

Solid wood sauna

ARKTIS

INFRA +

234 x 206 x 204 cm

INSTRUCTIONS FOR INSTALLATION AND USE
English

EN

DE

FR



Table of Contents

| | |
|----------------------------------------------------|-----------|
| 1. Preparing for installation | 3 |
| 1.1. Tools required | 4 |
| 1.2. Maintenance and cleaning | 5 |
| 1.3. Disposal | 5 |
| 1.4. ARKTIS INFRA+ parts list | 6 |
| 2. Cabin installation | 9 |
| 2.1. Base frame installation | 9 |
| 2.2. Wall element assembly | 10 |
| 2.3. Ceiling installation | 17 |
| 2.4. Ventilation slit installation | 19 |
| 2.5. Installing interior fittings | 19 |
| 2.6. Installing accessories | 26 |
| 2.7. Installing glass door | 28 |
| 2.8. Installing roof trim | 31 |
| 2.9. Installing ceiling cover slat | 32 |
| 3. Floor plan | 33 |
| 3.1. Left floor plan | 33 |
| 3.2. Right floor plan | 34 |
| 3.3. Changes for the right floor plan installation | 35 |

1. Preparing for installation

Read these assembly instructions carefully and keep them within reach when using the sauna so that you can look up product information at any time.



These assembly instructions can also be found in the downloads section of our website: www.sentiotec.com/downloads.

Important note:

- Before you begin work, check the parts list to ensure that all the individual parts have been delivered. If you discover any missing parts, notify your dealer within 14 days of receiving the sauna cabin.
- The room that the sauna is installed in must be dry and ensure an appropriate amount of air circulation.
- The floor must be level and even, preferably a stone or tiled floor.
- A minimum room height of 230 cm is required for the cabin installation work.
- A distance of at least 5 cm from the wall must be maintained.
- The inside of the wooden parts used must not be handled with any impregnating material.
- You need an assistant for the installation.
- Wood is a natural product that can swell, shrink or warp, despite good storage. For this reason, some force may be necessary during the installation.
- All screw fittings must be pre-drilled.

Attention!

The electrical connection may only be performed by a qualified electrician or similarly qualified person.

1.1. Tools required

- Hammer with a wooden head or a mallet
- Cordless screwdriver with bits for cross-head screws and Torx
- Roller tape measure
- Drill bits with a diameter of 3 mm, 10 mm, 20 - 30 mm (for sauna heater power cable)
- Spirit level
- 1.5 mm hexagonal socket wrench
- Utility knife
- Ladder
- Backsaw



This symbol indicates tips and useful information



Pre-drill



Cut to real measurement with backsaw



Check the right angle:

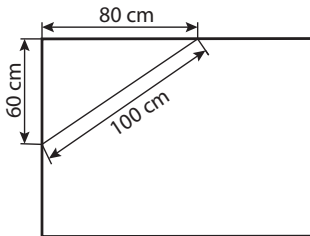

Handle glass with care: Special care must be taken with the edges of the glass – hardened glass can shatter into small pieces in the event of impact. Insert protective cushioning (e.g: cardboard box) under the edge of the glass.

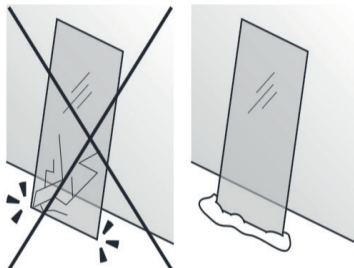

1.2. Maintenance and cleaning

- The sauna should be cleaned with a damp cloth. Only use warm water – no cleaning products.
- We recommend heating the cabin once a month if the sauna is not used for a long time.



Pitch pockets are not grounds for return, since they can always appear in spruce wood and the depth at which they lie cannot be detected during the sorting-out process.

If these are just under the surface, heat can cause them to soften and “bleed”.

The leaking pitch can be removed with a rag soaked in acetone. If only droplets of pitch occur, allow these to harden and then carefully scrape them off with a knife.

EN

1.3. Disposal

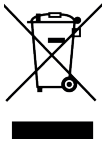

- Please dispose of packaging materials in accordance with the applicable disposal regulations.
- Used units contain reusable materials as well as hazardous substances. Therefore, do not dispose of your used unit with household waste, but rather do so in accordance with the locally applicable regulations.

1.4. ARKTIS INFRA+ parts list

| No. of items | Name | Dimensions |
|-------------------------|----------------------------------------------------|-------------------|
| Base frame | | |
| 2 | Base frame | 204 x 9 x 4 cm |
| 1 | Base frame | 138 x 9 x 4 cm |
| 1 | Base frame | 61.5 x 9 x 4 cm |
| 1 | Base frame | 32 x 9 x 4 cm |
| Wall elements | | |
| 1 | A/B wall elements with heater recess | 193 x 48 x 4 cm |
| 1 | A/B wall elements | 193 x 48 x 4 cm |
| 1 | A/B wall elements with Multiclip | 193 x 48 x 4 cm |
| 1 | A/B ventilation element with Multiclip | 193 x 48 x 4 cm |
| 1 | A/A wall element with Multiclip | 193 x 44 x 4 cm |
| 1 | A/A electrical element with Multiclip | 193 x 44 x 4 cm |
| 1 | A/A wall element | 193 x 44 x 4 cm |
| 1 | A/A wall element with Multiclip | 193 x 55.5 x 4 cm |
| 2 | A/B wall element with Multiclip | 193 x 55 x 4 cm |
| 1 | A/B wall element with heater recess | 193 x 55 x 4 cm |
| 1 | A/B wall element | 193 x 55 x 4 cm |
| 1 | Element above glass | 45.5 x 8.6 x 4 cm |
| 1 | Element above glass | 44 x 8.6 x 4 cm |
| Ceiling elements | | |
| 1 | A/B ceiling elements | 194 x 55 x 4 cm |
| 1 | A/B ceiling element | 194 x 56 x 4 cm |
| 1 | A/A ceiling element | 138.6 x 56 x 4 cm |
| 1 | A/A ceiling element, diagonal | 194 x 55 x 4 cm |
| Corner posts | | |
| 3 | 90° corner posts with Multiclip | 193 x 6 x 6 cm |
| 2 | 45° corner posts next to door with Multiclip | 202 x 7.8 x 4 cm |
| 1 | Corner post 90° with groove and Multiclip | 202 x 7.8 x 4 cm |
| 1 | Post for glass element, 8 mm groove with Multiclip | 202 x 4.5 x 4 cm |

| No. of items | Name | Dimensions |
|--------------------------|-------------------------------------------------------------------|--------------------|
| Support slats | | |
| 2 | Roof support slat | 115 x 4 x 4 cm |
| 1 | Roof support slat | 196 x 4 x 4 cm |
| 1 | Roof support slat | 136 x 4 x 4 cm |
| 1 | Roof support strip 1 x 22.5° | 54 x 4 x 4 cm |
| 1 | Roof support slat 1 x 22.5° | 112 x 4 x 4 cm |
| 1 | Roof support slats 2 x 22.5° | 86.5 x 4 x 4 cm |
| 2 | Roof support slat | 114 x 1.2 x 4 cm |
| 1 | Roof support slat | 200 x 1.2 x 4 cm |
| 1 | Roof support slat | 140 x 1.2 x 4 cm |
| 1 | Roof support slat 1 x 22.5° | 54.8 x 1.2 x 4 cm |
| 1 | Roof support slat 1 x 22.5° | 114.8 x 1.2 x 4 cm |
| 1 | Roof support slat 2 x 22.5° | 86.5 x 1.2 x 4 cm |
| 1 | Bench support slat 1 x 45° | 116 x 4 x 4 cm |
| 1 | Bench support slat | 110 x 4 x 4 cm |
| 3 | Bench support slats | 58 x 4 x 4 cm |
| 2 | Mounting slats for bench screen | 26 x 4 x 4 cm |
| Interior fittings | | |
| 2 | Benches | 195 x 62 x 9 cm |
| 1 | Bench | 161.5 x 62 x 9 cm |
| 1 | Bench cover slat | 45.7 x 14 x 2 cm |
| 1 | Backrests | 122 x 26 x 5 cm |
| 1 | Backrests | 105 x 26 x 5 cm |
| 1 | Backrests | 67 x 26 x 5 cm |
| 1 | Backrests | 56 x 26 x 5 cm |
| 1 | Bench screen | 195 x 35 x 5 cm |
| 1 | Heater safety guard, 3 parts 1 x 65.5 x 75 cm, 2x 45.5 x 55 cm | 65.5 x 475 x 75 cm |
| 1 | Floor grid | 70 x 53 x 4 cm |
| 2 | Headrests | 43 x 25 x 7 cm |
| 1 | Lamp protection grille | 38 x 32 x 4 cm |
| 1 | Ventilation slit | 52 x 14 x 1.5 cm |

| No. of items | Name | Dimensions |
|------------------------|-------------------------------------------|-----------------------|
| Glass elements | | |
| 1 | Glass door | 191.5 x 68 x 0.8 cm |
| 1 | Glass element | 194.5 x 48.1 x 0.8 cm |
| 1 | Glass element | 194.5 x 46.4 x 0.8 cm |
| Roof trim slats | | |
| 1 | Roof trim slat 1 x 45° | 151 x 6 x 4 cm |
| 1 | Roof trim slat 1 x 22.5° and 1 x 45° | 56.3 x 6 x 4 cm |
| 1 | Roof trim slat 1 x 22.5° | 123.5 x 6 x 4 cm |
| 1 | Roof trim slat 2 x 22.5° | 84.9 x 6 x 4 cm |
| Accessories | | |
| 1 | U aluminium profile | 45.7 x 1.2 x 1.5 cm |
| 1 | U aluminium profile | 44 x 1.2 x 1.5 cm |
| 1 | Door handle set wood/stainless steel | |
| 1 | 2 door hinges 3308 | |
| 1 | Door magnet, sleeve plate | |
| 1 | Sauna lamp | |
| 2 | Infrared radiator ECO-350-R | 1-027-785 |
| 2 | Prestige radiator covers | 71 x 21 x 5 cm |
| 1 | Infrabox basic Set | 1-035-705 |
| 1 | Cable WC4-GST-C05 | 1-028-862 |
| 1 | Distributor IR-1P2 | 1-028-731 |
| 1 | Template for Multiclip installation | |
| 1 | 3 Silicon cables: 5 x 2.5 mm ² | |
| 1 | 3 Silicon cables: 3 x 1.5 mm ² | |
| 1 | Installation material set | |
| 1 | Installation instructions | |

2. Cabin installation

The cabin can have a right or left set-up; please note the corresponding floor plans on Page 33 and Page 34.

2.1. Base frame installation

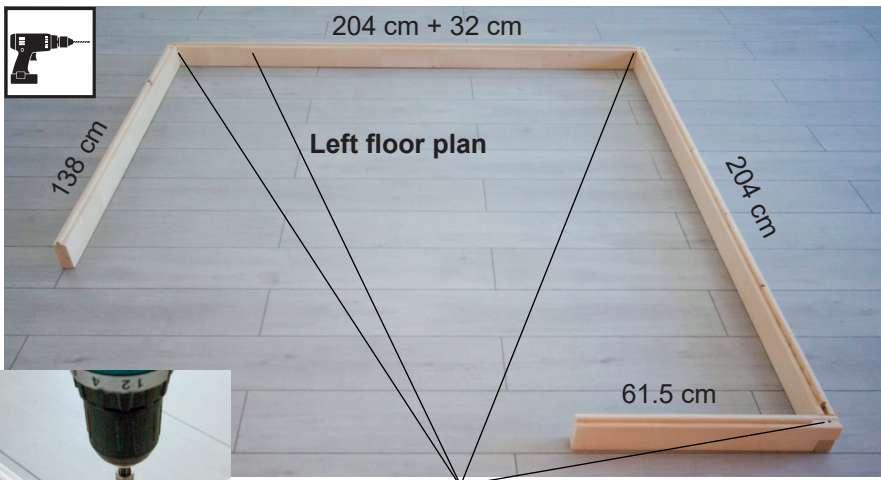

3 mm drill bit, 4 screws 4 x 70 mm

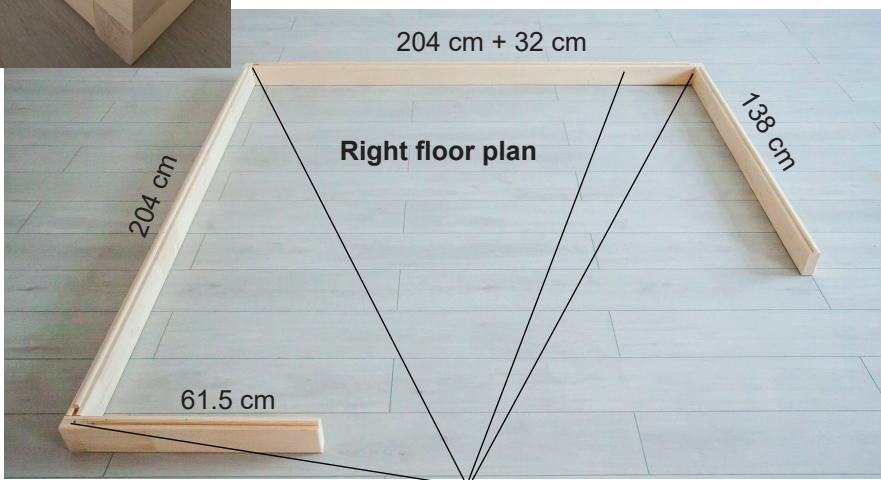

3 mm drill bit, 4 screws 4 x 70 mm

2.2. Wall element assembly

The corner posts are connected to the wall elements using Multiclips. The other wall elements are connected tongue and groove and are screwed together.



A always refers to the visible side. This is labelled on the top side of the wall elements.

Attention!

The installation subsequently described is for the left floor plan. For changes affecting the installation for the right floor plan, see Page 34.

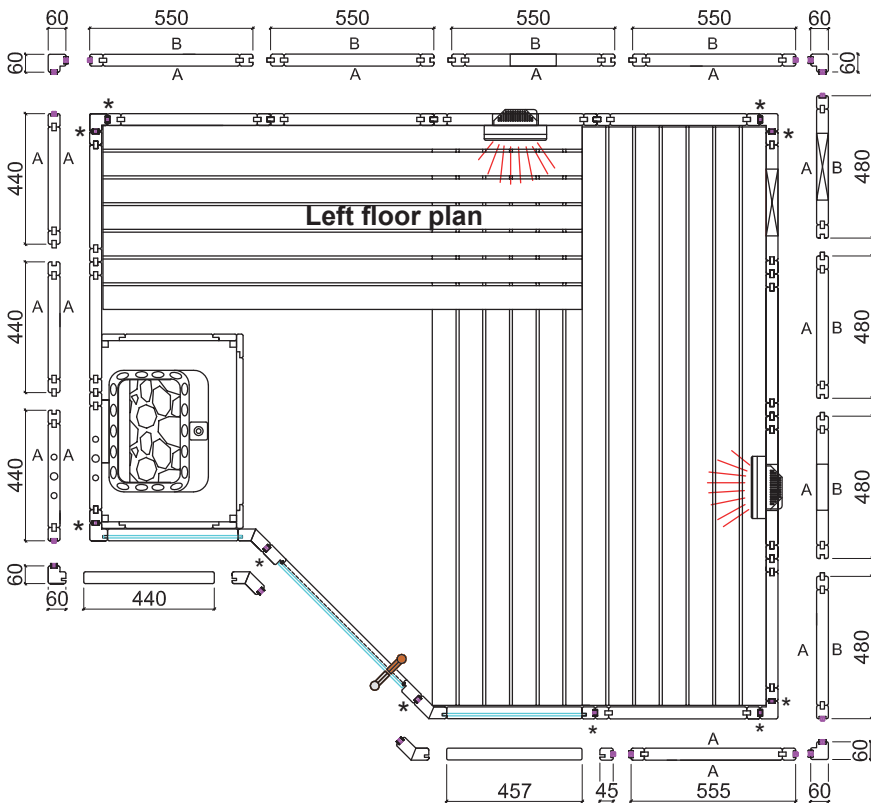

* Multiclips

Installing corner posts with wall elements



Pre-assemble the wall elements with the corner posts on the floor and then place these posts on the base frame.

Insert the corner post from above down onto the wall elements. When doing this, ensure that the Multiclips are correctly aligned (see below). The corner post must be flush with the wall elements.

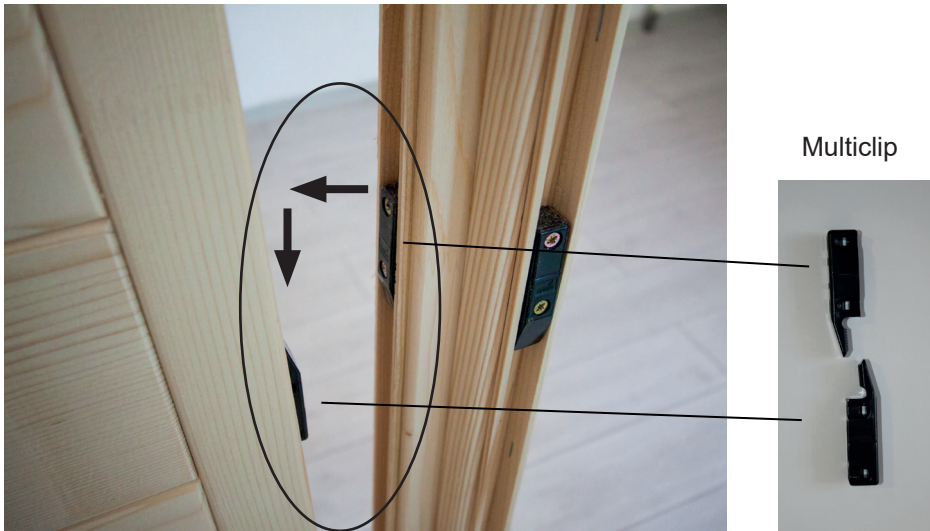

Installing wall elements



The electrical element has drill holes for laying cables. For the position see floor plans on Page 33 and Page 34.

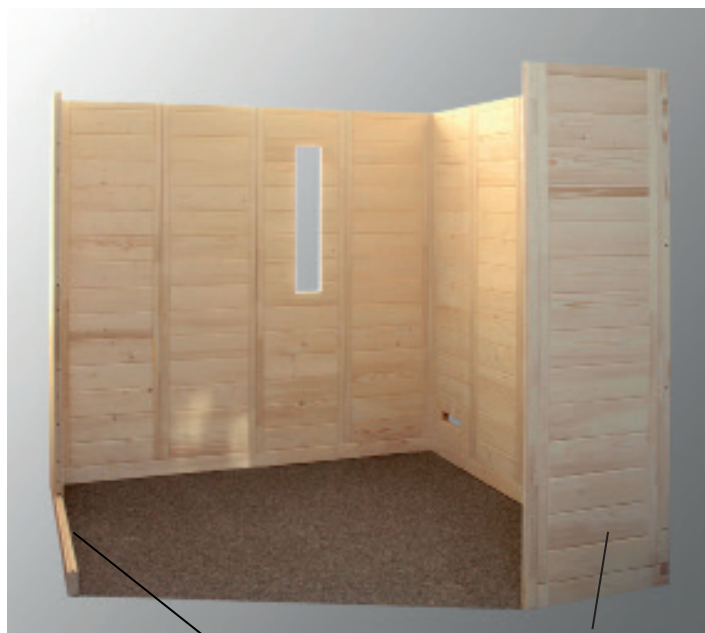

Electrical element

Width 55.6 cm

Screwing wall elements together



Check the right angle before screwing the wall elements together.
Observe the tip on page 4.



EN

3 mm drill bit, 8 screws 4 x 70 mm

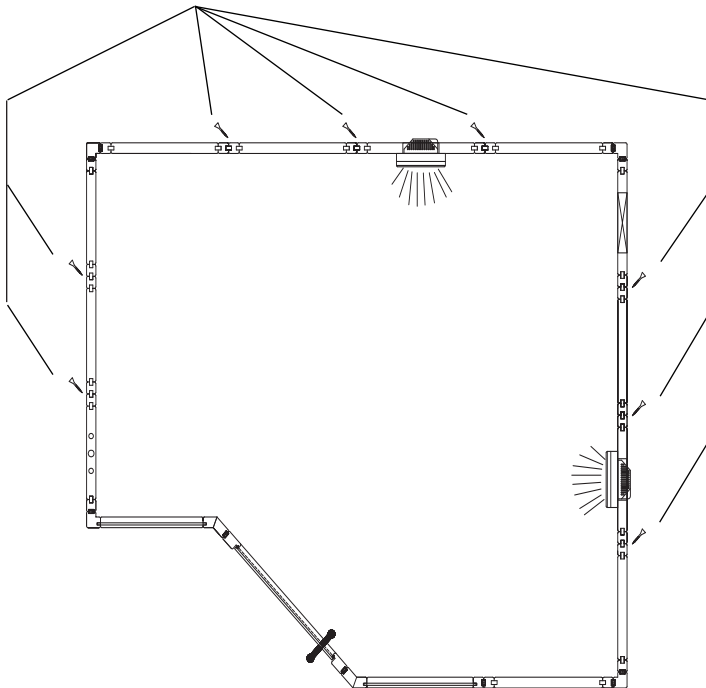

Corner post and post for glass



Glass elements

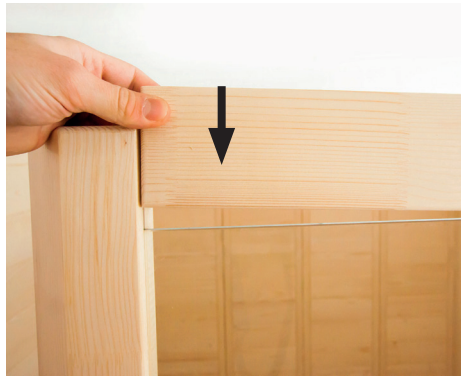

EN



3 mm drill bit,
1 screw 4 x 70 mm



3 mm drill bit,
1 screw 4 x 70 mm

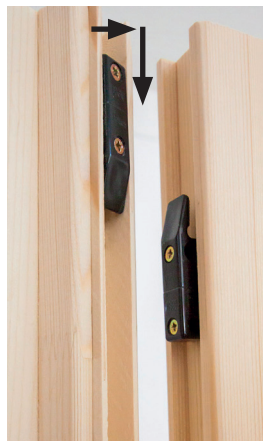

Türstock einsetzen



Remove transport strip from the door frame



Insert door frame

2.3. Ceiling installation

Roof support slats



EN

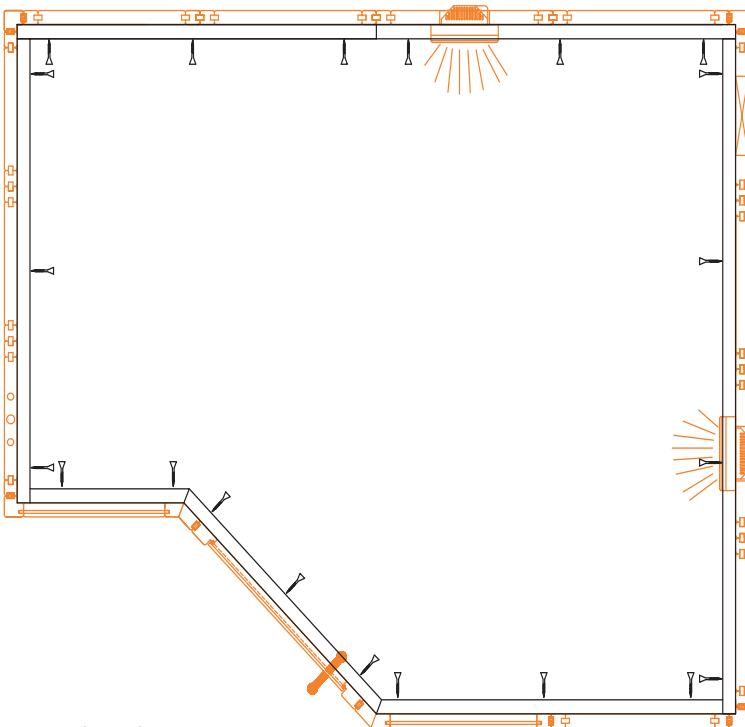

21 screws 4 x 70 mm

Ceiling elements

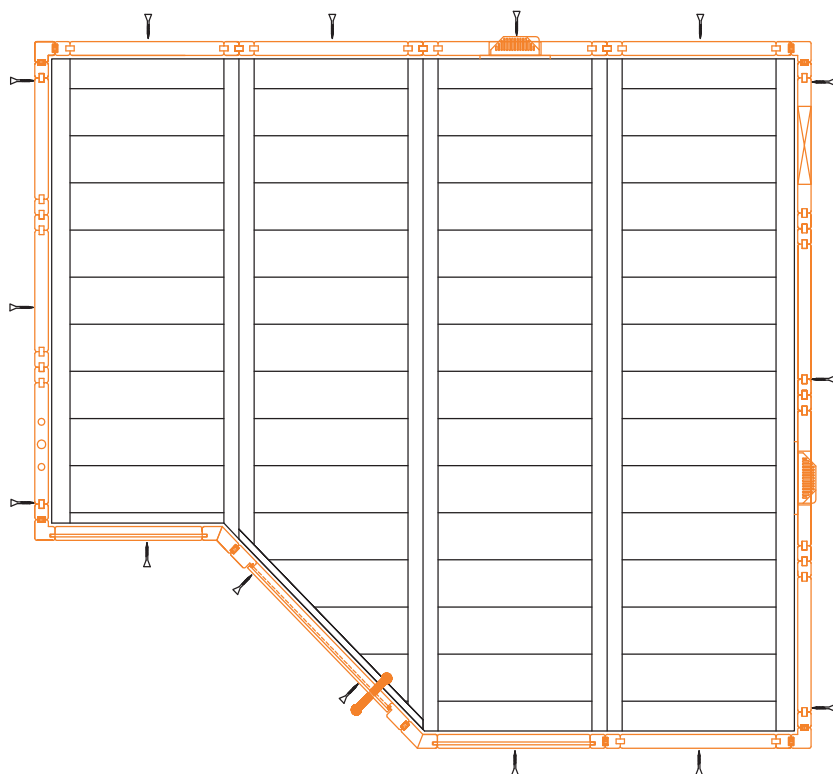

3 mm drill bit, 15 screws 4 x 70 mm

2.4. Ventilation slit installation



3 mm drill bit, 4 screws 3.5 x 40 mm

2.5. Installing interior fittings

Bench support slats

3 mm drill bit, 3 screws 5 x 70 mm



2 screws 4 x 60 mm

3 mm drill bit, 3 screws 5 x 70 mm

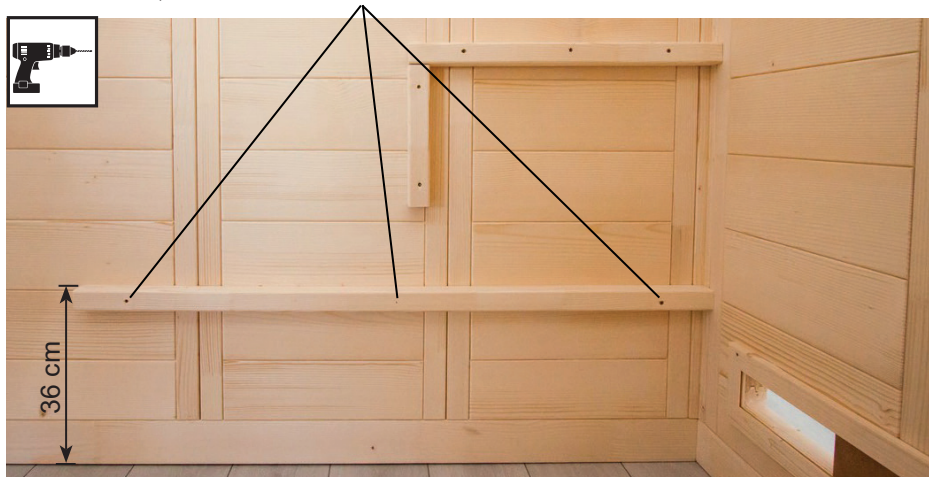

3 mm drill bit, 3 screws 5 x 70 mm

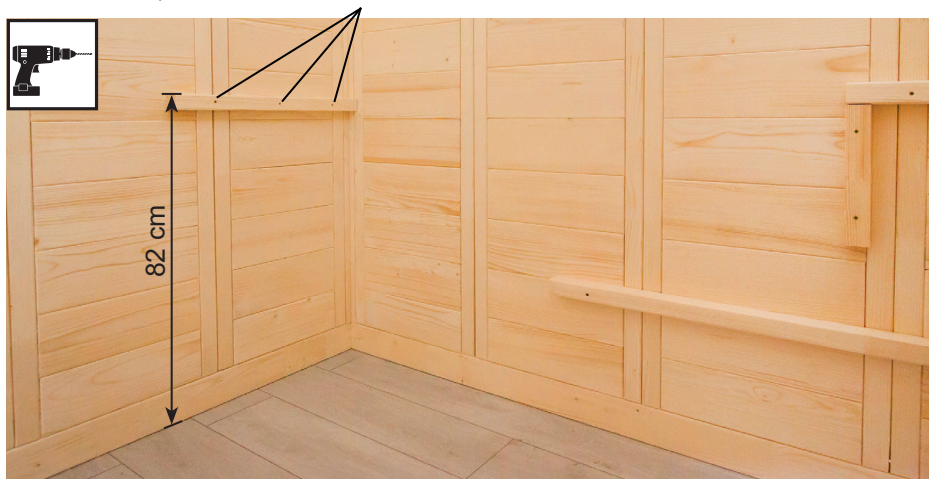

Bench support slat with cover in front of glass element



2 screws 4 x 60 mm



3 screws 5 x 70 mm



2 screws 4 x 60 mm



EN

Bench screen



4 screws 4 x 60 mm

Bench

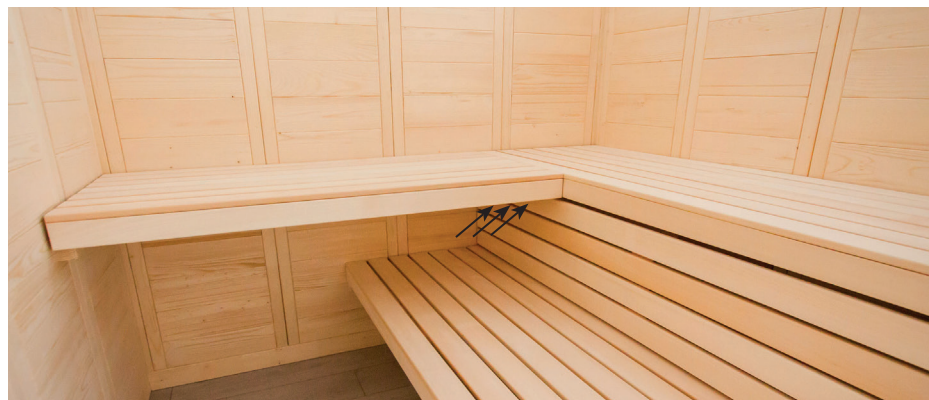

3 mm drill bit, 3 screws 5 x 70 mm



Infrared radiator and backrests

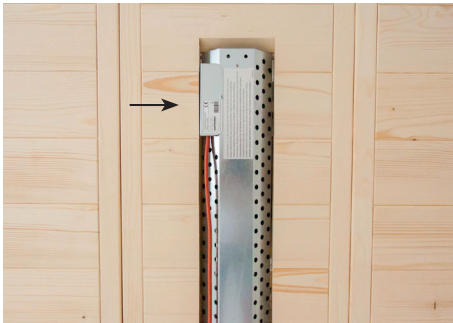

Connection box, top



Label legible



4 screws 3 x 18 mm



4 screws 4 x 60 mm



3 mm drill bit, 8 screws 3.5 x 40 mm

2.6. Installing accessories

Sauna lamp



Insert lamp
(not included in the scope of delivery)



3 mm drill bit, 2 screws

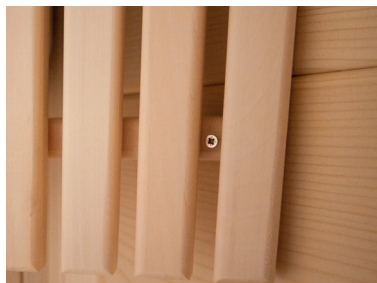

4 screws 3.5 x 40 mm

Heater protection grille



Before installing the heater protection grille, drill the outlet for the heater cable in the electrical element.



4 screws 3.5 x 40 mm

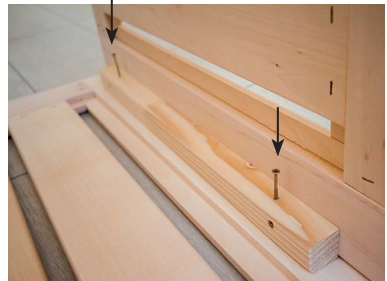

EN



Symbol photo

4 screws 3.5 x 40 mm



2.7. Installing glass door

The glass door can be hinged to the left or right.

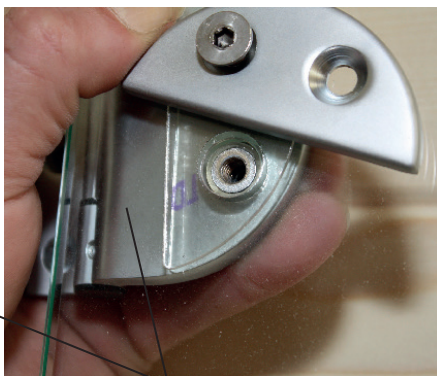
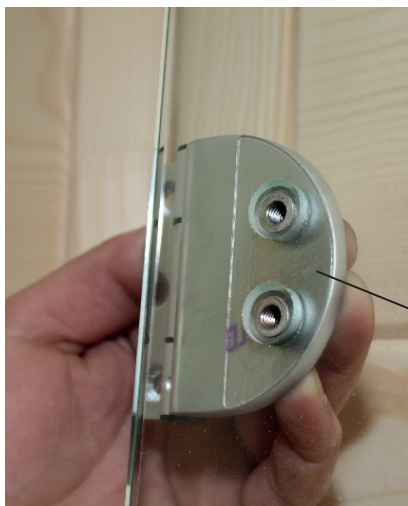

Insert a silicone or paper insert for glass door fittings on both sides of the glass door.

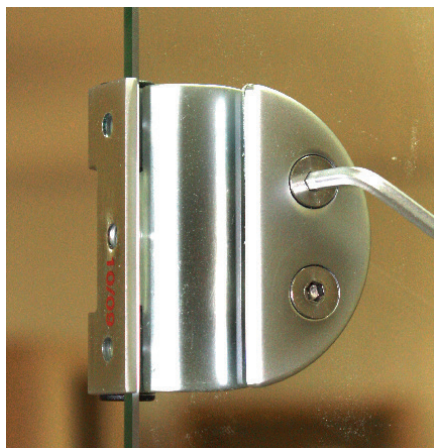

Screws 4 x 30 mm

Door handle and sleeve plate

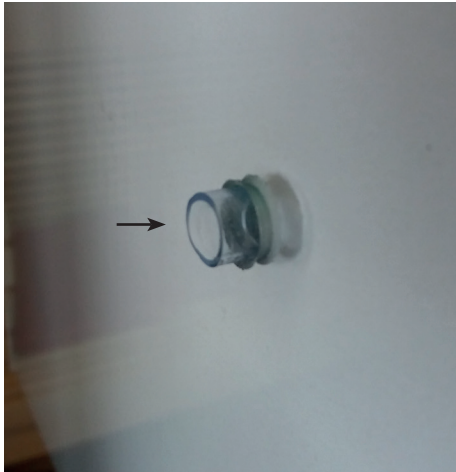

Insert silicone ring in the drill holes



Attach plastic washers on the stainless steel handle



Door magnet

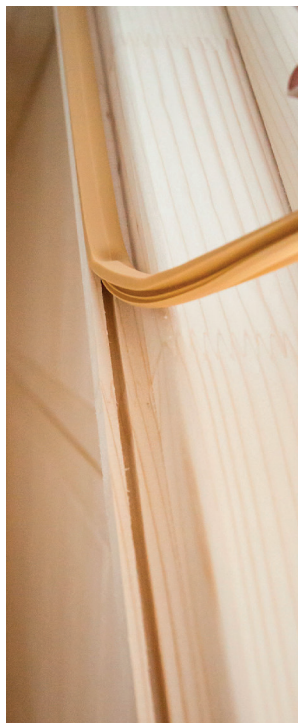

2.8. Installing roof trim



Install the roof trim only after you have inserted the cable to the sauna heater and to the sauna control unit. The slat on the electrical element may possibly have to be cropped.

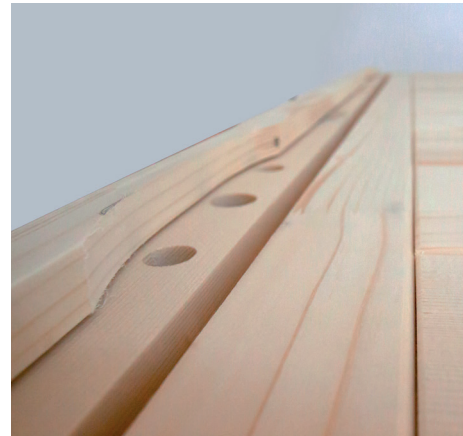

3 mm drill bit, 11 screws 3.5 x 40 mm

2.9. Installing ceiling cover slat



Install the ceiling cover slat only after you have inserted the cable to the sauna heater and to the sauna control unit. The slat on the electrical element may possibly have to be cropped.



20 screws 3.5 x 40 mm

3. Floor plan

3.1. Left floor plan

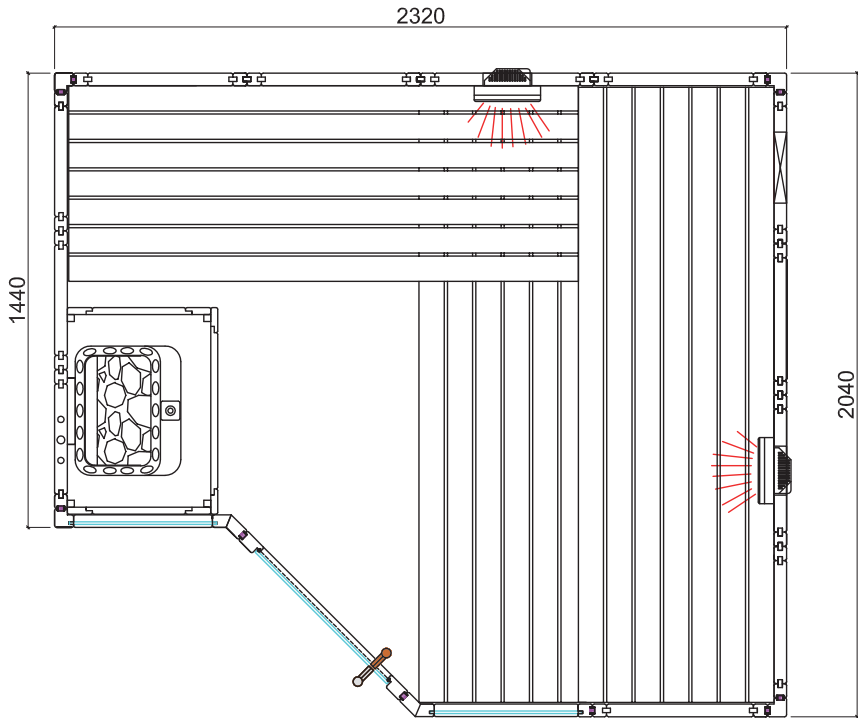

3.2. Right floor plan

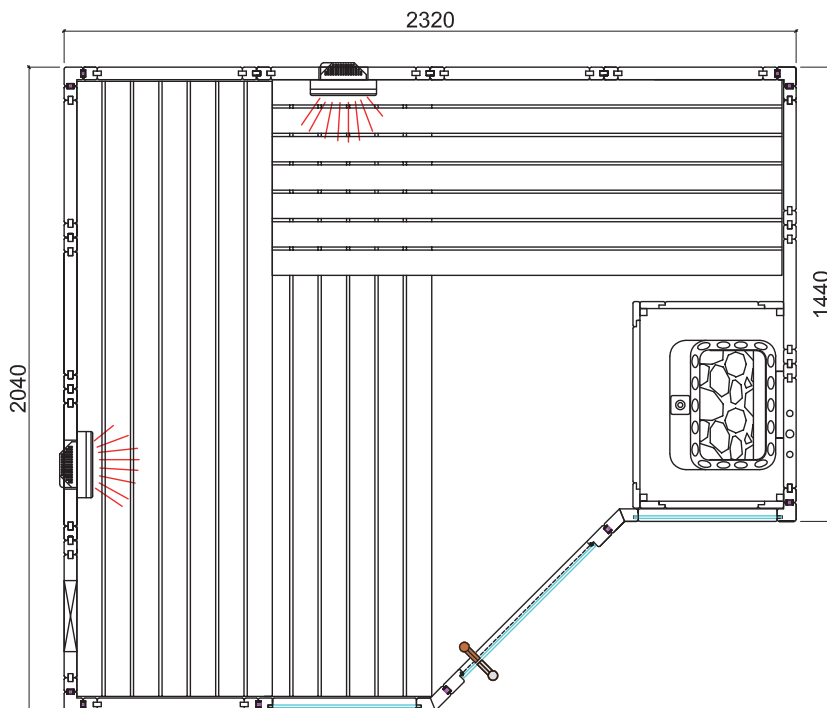

3.3. Changes for the right floor plan installation

For installing corner posts and posts for the glass (page 14)

Remove the Multiclips from the corner posts and the post for the glass.
Use the supplied template for the new positioning of the Multiclips.

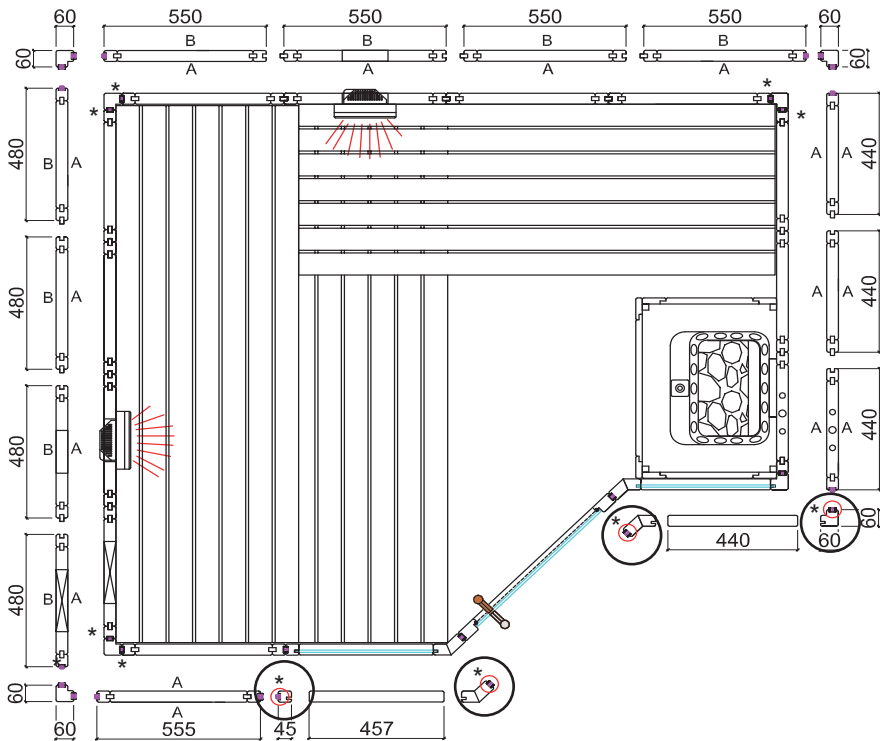

* Multiclips

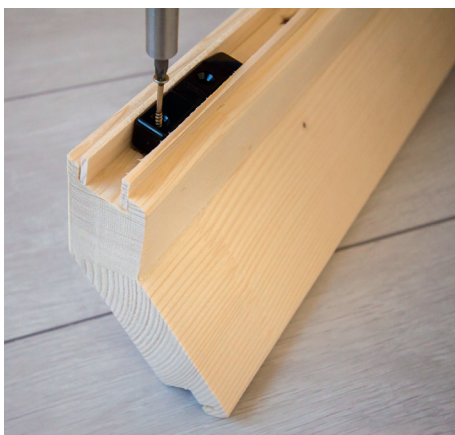

Massivsauna

ARKTIS

INFRA +

234 x 206 x 204 cm

MONTAGEANLEITUNG

Deutsch

DE



Inhaltsverzeichnis

| | |
|------------------------------------------------|-----------|
| 1. Montage Vorbereitung | 3 |
| 1.1. Benötigtes Werkzeug | 4 |
| 1.2. Wartung und Reinigung | 5 |
| 1.3. Entsorgung | 5 |
| 1.4. Stückliste ARKTIS INFRA+ | 6 |
| 2. Montage der Kabine | 9 |
| 2.1. Montage des Bodenrahmens | 9 |
| 2.2. Montage der Wandelemente | 10 |
| 2.3. Montage Dach | 17 |
| 2.4. Montage Lüftungsschieber | 19 |
| 2.5. Montage Inneneinrichtung | 19 |
| 2.6. Montage Zubehör | 26 |
| 2.7. Montage Glastür | 28 |
| 2.8. Montage Dachkranz | 31 |
| 2.9. Montage Dachabdeckleiste | 32 |
| 3. Grundriss | 33 |
| 3.1. Grundriss „links“ | 33 |
| 3.2. Grundriss „rechts“ | 34 |
| 3.3. Änderungen bei Montage Grundriss „rechts“ | 35 |

1. Montage Vorbereitung

Lesen Sie diese Montageanleitung gut durch und bewahren Sie sie in der Nähe der Sauna auf. So können Sie jederzeit Produktinformationen nachlesen.



Sie finden diese Montageanleitung auch im Downloadbereich unserer Webseite auf www.sentiotec.com/downloads.

Wichtige Hinweise:

- Kontrollieren Sie, bevor Sie mit der Arbeit beginnen, anhand der Stückliste, ob alle Einzelteile auch tatsächlich mitgeliefert wurden. Sollten Einzelteile ausnahmsweise fehlen, benachrichtigen Sie spätestens 14 Tage nach Erhalt der Kabine Ihren Händler.
- Der Raum, in dem die Saunakabine montiert wird, muss trocken sein und eine entsprechende Luftzirkulation gewährleisten.
- Der Fußboden muss waagrecht und eben sein, bevorzugt Stein- oder Fliesenboden.
- Für die Montagearbeiten der Kabine wird eine Mindestraumhöhe von 230 cm benötigt.
- Es muss ein Wandabstand von mindestens 5 cm eingehalten werden.
- Die Innen zu verwendenden Holzteile dürfen nicht mit Imprägniermittel behandelt werden.
- Für die Montage benötigen Sie einen Helfer.
- Holz ist ein Naturprodukt, das trotz guter Lagerung aufquellen, schwinden oder sich verziehen kann. Aus diesem Grund kann es vorkommen, dass bei der Montage etwas Kraft aufgebracht werden muss.
- Alle Verschraubungen müssen vorgebohrt werden.

Achtung!

Der Elektroanschluss darf nur durch eine Elektrofachkraft oder eine vergleichsweise qualifizierte Person ausgeführt werden.

1.1. Benötigtes Werkzeug

- Hammer und Beilageholz oder einen Gummihammer
- Akkuschauber mit Bits für Kreuzschrauben und Torx
- Rollmaßband
- Bohrer mit Durchmesser 3 mm, 10 mm, 20 - 30 mm (für Stromkabel Saunaofen)
- Wasserwaage
- Innensechskant-Schlüssel 1,5 mm
- Universalmesser
- Leiter
- Feinsäge



Dieses Symbol kennzeichnet Tipps und nützliche Hinweise



Vorbohren



Ablängen auf Naturmaß mit Feinsäge



Überprüfung des rechten Winkel:

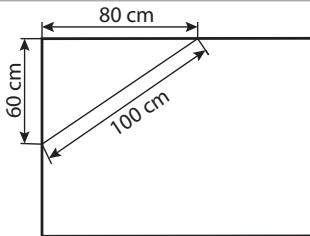

Vorsichtiger Umgang mit Glas: Besondere Vorsicht gilt den Glaskanten - Gehärtetes Glas kann bei Stößen in kleine Scherben zerspringen. Legen Sie ein Schutzpolster (z.Bsp.: Verpackungs-Karton) unter die Glaskante.

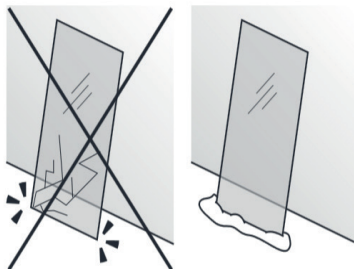

1.2. Wartung und Reinigung

- Die Sauna sollte mit einem feuchten Tuch gereinigt werden. Verwenden Sie nur warmes Wasser - keine Reinigungsmittel.
- Wird die Sauna längere Zeit nicht benutzt, empfehlen wir, die Kabine einmal im Monat aufzuheizen.



Harzgallen sind kein Reklamationsgrund. Da in Fichtenholz immer wieder Harzgallen vorkommen und man beim Aussortieren nicht erkennen kann in welcher Tiefe diese sich befinden.

Wenn diese knapp unter der Oberfläche sind brechen sie bei Hitzeentwicklung auf und „bluten“ aus.

Das ausgelaufene Harz kann man mit einem Aceton gedrängtem Lappen entfernen. Wenn lediglich Harztropfen entstehen, lassen Sie diese aushärten und schaben sie anschließend mit einem Messer vorsichtig ab.

DE

1.3. Entsorgung



- Entsorgen Sie die Verpackungsmaterialien nach den gültigen Entsorgungsrichtlinien.
- Altgeräte enthalten wiederverwendbare Materialien, aber auch schädliche Stoffe. Geben Sie Ihr Altgerät deshalb auf keinen Fall in den Restmüll, sondern entsorgen Sie das Gerät nach den örtlich geltenden Vorschriften.

1.4. Stückliste ARKTIS INFRA+

| Az | Bezeichnung | Maß |
|---------------------|-----------------------------------------------|-------------------|
| Bodenrahmen | | |
| 2 | Bodenrahmen | 204 x 9 x 4 cm |
| 1 | Bodenrahmen | 138 x 9 x 4 cm |
| 1 | Bodenrahmen | 61,5 x 9 x 4 cm |
| 1 | Bodenrahmen | 32 x 9 x 4 cm |
| Wandelemente | | |
| 1 | Wandelemente A/B mit Strahlerausschnitt | 193 x 48 x 4 cm |
| 1 | Wandelemente A/B | 193 x 48 x 4 cm |
| 1 | Wandelemente A/B mit Multiclip | 193 x 48 x 4 cm |
| 1 | Lüftungselement A/B mit Multiclip | 193 x 48 x 4 cm |
| 1 | Wandelement A/A mit Multiclip | 193 x 44 x 4 cm |
| 1 | Elektroelement A/A mit Multiclip | 193 x 44 x 4 cm |
| 1 | Wandelement A/A | 193 x 44 x 4 cm |
| 1 | Wandelement A/A mit Multiclip | 193 x 55,5 x 4 cm |
| 2 | Wandelement A/B mit Multiclip | 193 x 55 x 4 cm |
| 1 | Wandelement A/B mit Strahlerausschnitt | 193 x 55 x 4 cm |
| 1 | Wandelement A/B | 193 x 55 x 4 cm |
| 1 | Element oberhalb Glas | 45,5 x 8,6 x 4 cm |
| 1 | Element oberhalb Glas | 44 x 8,6 x 4 cm |
| Dachelemente | | |
| 1 | Dachelemente A/B | 194 x 55 x 4 cm |
| 1 | Dachelement A/B | 194 x 56 x 4 cm |
| 1 | Dachelement A/A | 138,6 x 56 x 4 cm |
| 1 | Dachelement A/A schräg | 194 x 55 x 4 cm |
| Ecksteher | | |
| 3 | Ecksteher 90° mit Multiclip | 193 x 6 x 6 cm |
| 2 | Ecksteher 45° neben Tür mit Multiclip | 202 x 7,8 x 4 cm |
| 1 | Ecksteher 90° mit Nut und Multiclip | 202 x 7,8 x 4 cm |
| 1 | Steher für Glaselement 8 mm Nut mit Multiclip | 202 x 4,5 x 4 cm |

| Az | Bezeichnung | Maß |
|-------------------------|--------------------------------------------------------------|--------------------|
| Auflageleisten | | |
| 2 | Dachauflageleiste | 115 x 4 x 4 cm |
| 1 | Dachauflageleiste | 196 x 4 x 4 cm |
| 1 | Dachauflageleiste | 136 x 4 x 4 cm |
| 1 | Dachauflageleiste 1x 22,5 ° | 54 x 4 x 4 cm |
| 1 | Dachauflageleisten 1 x 22,5° | 112 x 4 x 4 cm |
| 1 | Dachauflageleiste 2 x 22,5° | 86,5 x 4 x 4 cm |
| 2 | Dachabdeckleiste | 114 x 1,2 x 4 cm |
| 1 | Dachabdeckleiste | 200 x 1,2 x 4 cm |
| 1 | Dachabdeckleiste | 140 x 1,2 x 4 cm |
| 1 | Dachabdeckleiste 1 x 22,5° | 54,8 x 1,2 x 4 cm |
| 1 | Dachabdeckleisten 1 x 22,5° | 114,8 x 1,2 x 4 cm |
| 1 | Dachabdeckleiste 2 x 22,5° | 86,5 x 1,2 x 4 cm |
| 1 | Bankauflageleiste 1 x 45° | 116 x 4 x 4 cm |
| 1 | Bankauflageleiste | 110 x 4 x 4 cm |
| 3 | Bankauflageleisten | 58 x 4 x 4 cm |
| 2 | Montageleisten für Banksichtblende | 26 x 4 x 4 cm |
| Inneneinrichtung | | |
| 2 | Bänke | 195 x 62 x 9 cm |
| 1 | Bank | 161,5 x 62 x 9 cm |
| 1 | Bankabdeckleiste | 45,7 x 14 x 2 cm |
| 1 | Rückenlehne | 122 x 26 x 5 cm |
| 1 | Rückenlehne | 105 x 26 x 5 cm |
| 1 | Rückenlehne | 67 x 26 x 5 cm |
| 1 | Rückenlehne | 56 x 26 x 5 cm |
| 1 | Banksichtblende | 195 x 35 x 5 cm |
| 1 | Ofenschutzgitter 3-tlg. 1 x 65,5 x 75 cm, 2x 45,5 x 55 cm | 65,5 x 475 x 75cm |
| 1 | Bodenrost | 70 x 53 x 4 cm |
| 2 | Kopfstützen | 43 x 25 x 7 cm |
| 1 | Lampenschutzgitter | 38 x 32 x 4 cm |
| 1 | Lüftungsschieber | 52 x 14 x 1,5 cm |

| Az | Bezeichnung | Maß |
|-------------------------|--------------------------------------------|-----------------------|
| Glaselemente | | |
| 1 | Glastür | 191,5 x 68 x 0,8 cm |
| 1 | Glaselement | 194,5 x 48,1 x 0,8 cm |
| 1 | Glaselement | 194,5 x 46,4 x 0,8 cm |
| Dachkranzleisten | | |
| 1 | Dachkranzleisten 1 x 45° | 151 x 6 x 4 cm |
| 1 | Dachkranzleiste 1 x 22,5° u. 1 x 45° | 56,3 x 6 x 4 cm |
| 1 | Dachkranzleiste 1 x 22,5° | 123,5 x 6 x 4 cm |
| 1 | Dachkranzleiste 2 x 22,5° | 84,9 x 6 x 4 cm |
| Zubehör | | |
| 1 | U Alu Profil | 45,7 x 1,2 x 1,5 cm |
| 1 | U Alu Profil | 44 x 1,2 x 1,5 cm |
| 1 | Türgriff Set Holz/Niro | |
| 1 | 2 Türbänder 3308 | |
| 1 | Türmagnet, Überschubblech | |
| 1 | Saunaleuchte | |
| 2 | Infrarotstrahler ECO-350-R | 1-027-785 |
| 2 | Strahlerabdeckblenden Prestige | 71 x 21 x 5 cm |
| 1 | Infrabox basic S Set | 1-035-705 |
| 1 | Kabel WC4-GST-C05 | 1-028-862 |
| 1 | Verteiler IR-1P2 | 1-028-731 |
| 1 | Schablone für Multiclip-Montage | |
| 1 | 3 Lfm. Silikonkabel 5 x 2,5mm ² | |
| 1 | 3 Lfm. Silikonkabel 3 x 1,5mm ² | |
| 1 | Montagematerialset | |
| 1 | Montageanleitung | |

2. Montage der Kabine

Die Kabine kann „links“ oder „rechts“ aufgebaut werden, beachten Sie dazu die Grundrisspläne auf Seite 33 und Seite 34.

2.1. Montage des Bodenrahmens

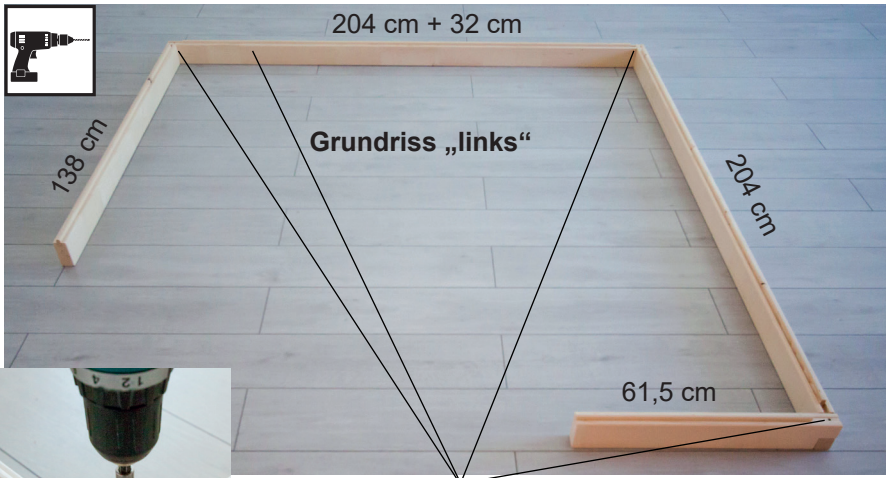

Bohrer 3mm, 4 Stk. Schrauben 4 x 70 mm

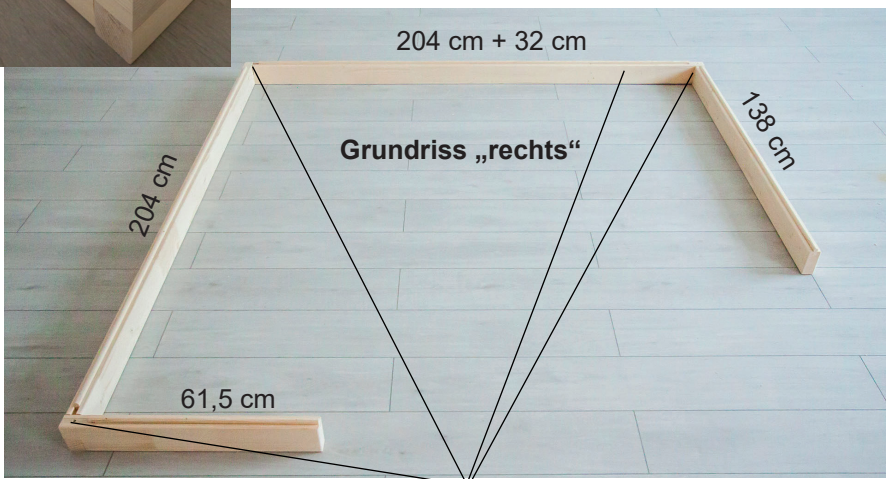

Bohrer 3mm, 4 Stk. Schrauben 4 x 70 mm

2.2. Montage der Wandelemente

Die Ecksteher werden mittels „Multiclips“ mit den Wandelementen verbunden. Die weiteren Wandelemente sind mit Nut und Feder verbunden und werden miteinander verschraubt.



A bezeichnet immer die Sichtseite, dies ist auf der Oberseite der Wandelemente gekennzeichnet.

Achtung!

In weiterer Folge wird die Montage für Grundriss „links“ beschrieben. Änderungen betreffend Montage für Grundriss „rechts“ - siehe Seite 34.

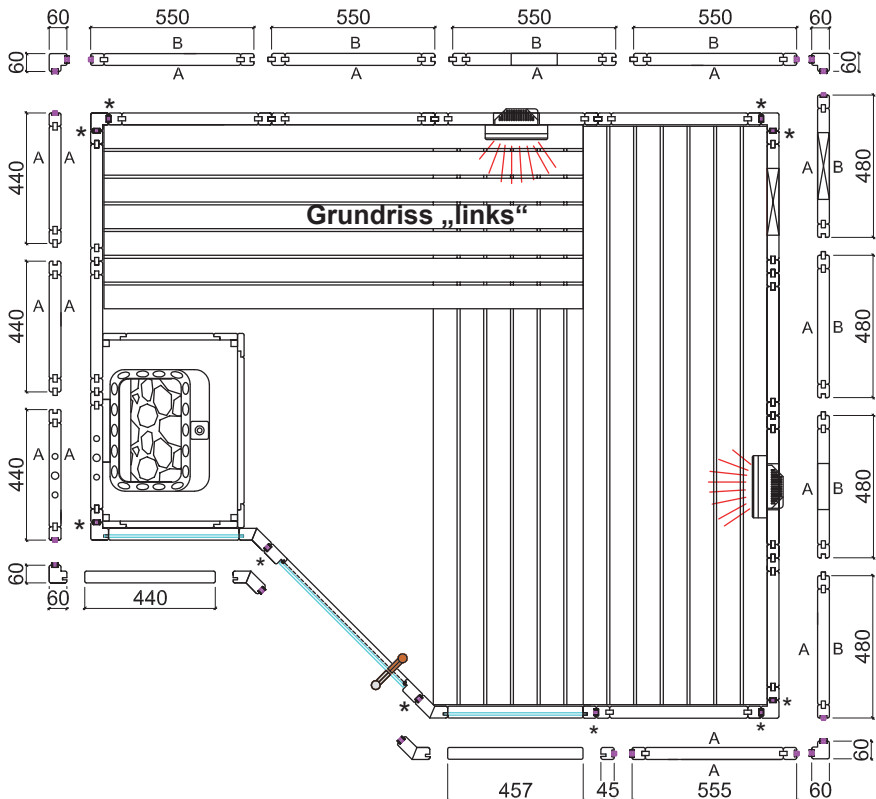

* Multiclips

Montage Ecksteher mit Wandelement



Montieren Sie die Wandelemente mit den Eckstehern am Boden vor und setzen Sie diese Ecken dann auf den Bodenrahmen auf.

Stecken Sie den Ecksteher von oben nach unten auf die Wandelemente. Achten Sie dabei auf die korrekte Ausrichtung der „Multiclip“ (siehe unten). Der Ecksteher muss bündig mit den Wandelementen sein.

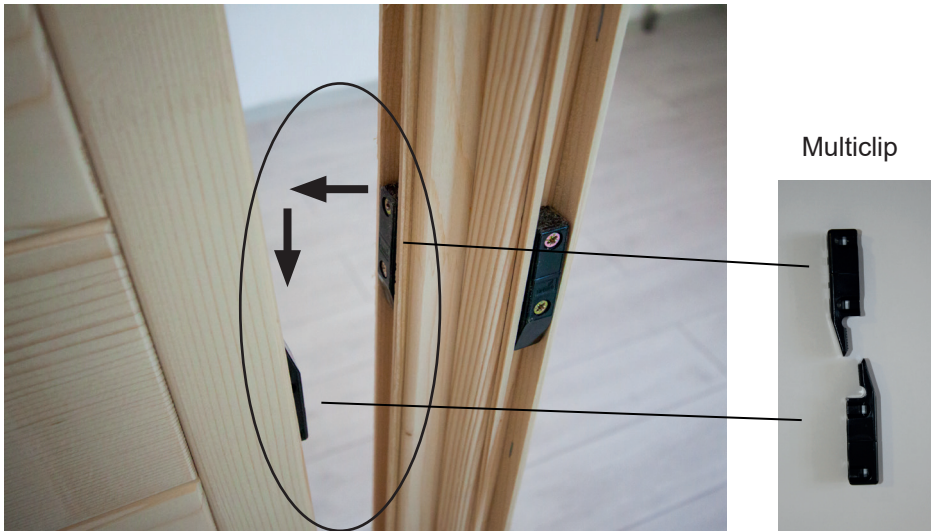

Montage Wandelemente

Das Elektroelement hat Bohrungen zum Verlegen der Kabel. Position siehe Grundrisspläne auf Seite 32 und Seite 33.

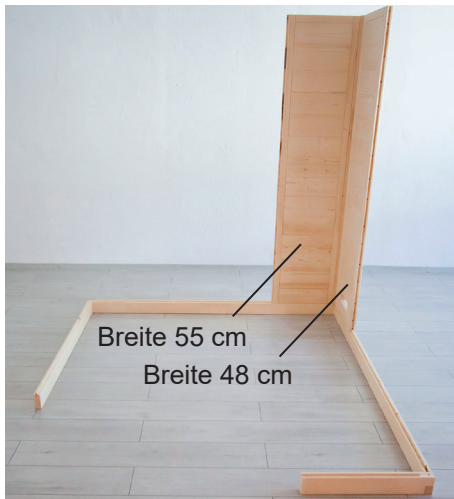

Verschrauben der Wandelemente



Überprüfen Sie die rechten Winkel, bevor Sie die Wandelemente verschrauben. Beachten Sie den Tipp auf Seite 4.



DE

Bohrer 3 mm, 8 Stk. Schrauben 4 x 70 mm

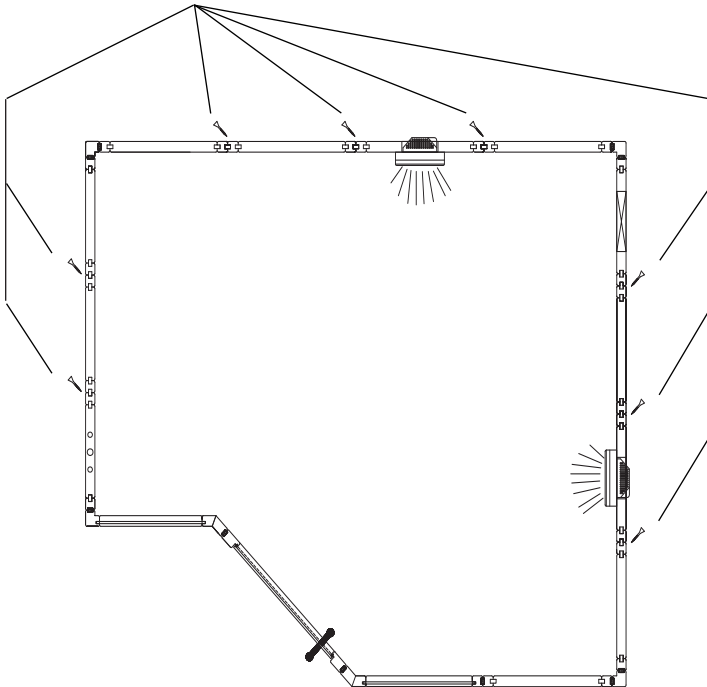

Ecksteher und Steher für Glas



Glaselemente

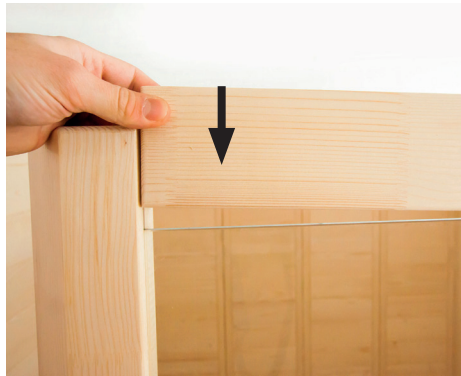

DE



Bohrer 3 mm,
1 Stk. Schrauben 4 x 70 mm



Bohrer 3 mm,
1 Stk. Schrauben 4 x 70 mm

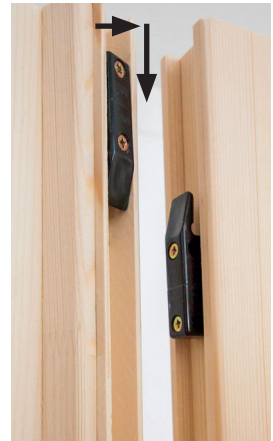

Türstock einsetzen



Transportleiste vom Türstock entfernen



Türstock einsetzen

2.3. Montage Dach

Dachauflageleisten

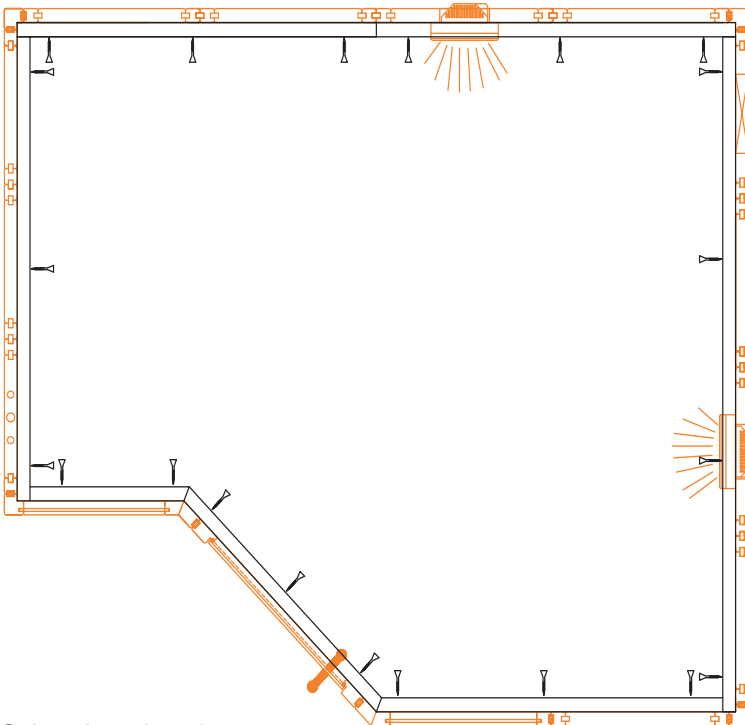

21 Stk. Schrauben 4 x 70 mm

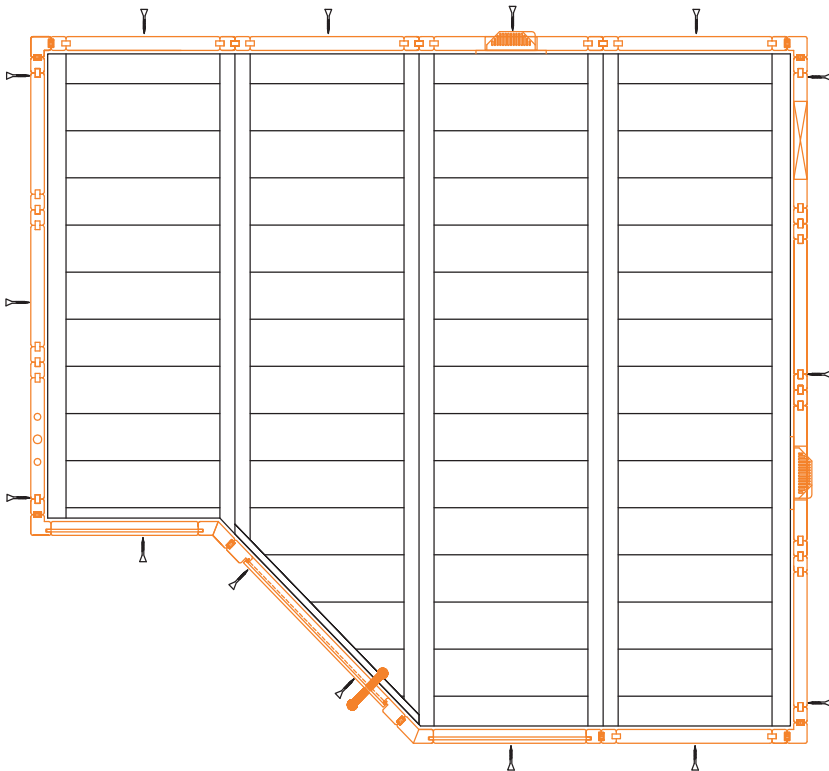
Dachelemente

Bohrer 3 mm, 15 Stk. Schrauben 4 x 70 mm

2.4. Montage Lüftungsschieber



Bohrer 3 mm, 4 Stk. Schrauben 3,5 x 40 mm

DE

2.5. Montage Inneneinrichtung

Bankauflageleisten

Bohrer 3 mm, 3 Stk. Schrauben 5 x 70 mm



2 Stk. Schrauben 4 x 60 mm

Bohrer 3 mm, 3 Stk. Schrauben 5 x 70 mm

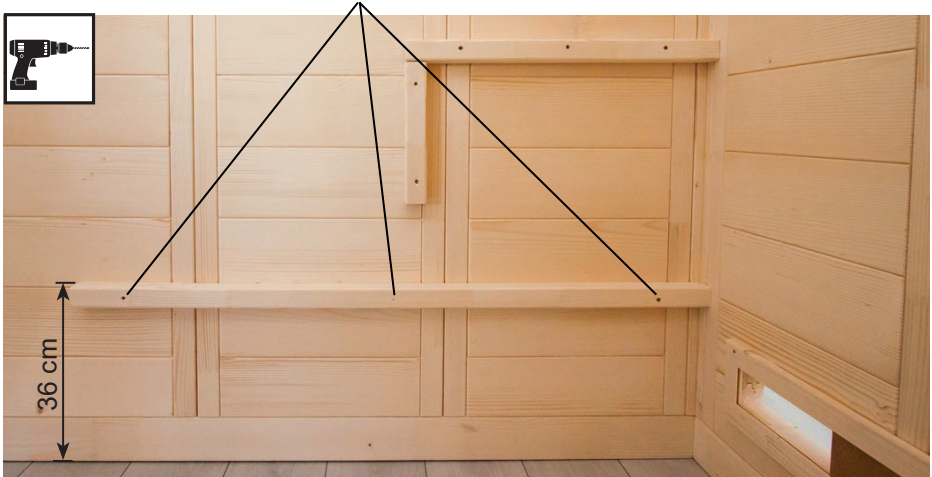

Bohrer 3 mm, 3 Stk. Schrauben 5 x 70 mm



Bankauflageleiste mit Abdeckblende vor dem Glasteil

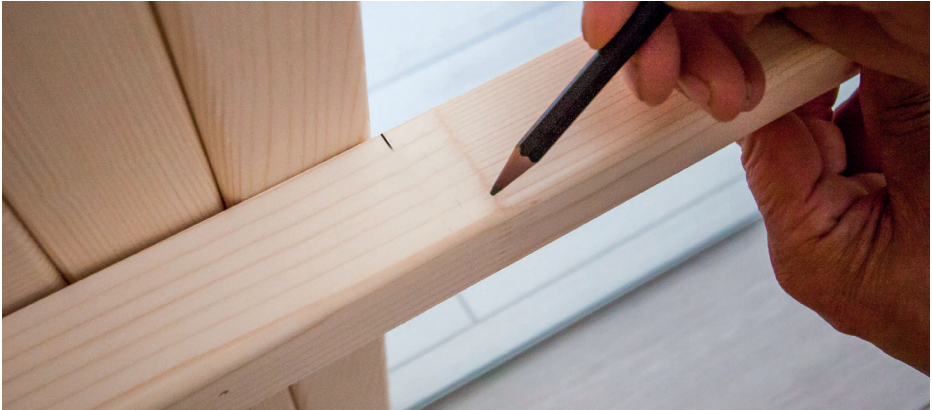

DE



2 Stk. Schrauben 4 x 60 mm



3Stk. Schrauben 5 x 70 mm



2 Stk. Schrauben 4 x 60 mm



Banksichtblende

DE



4 Stk. Schrauben 4 x 60 mm

Bank

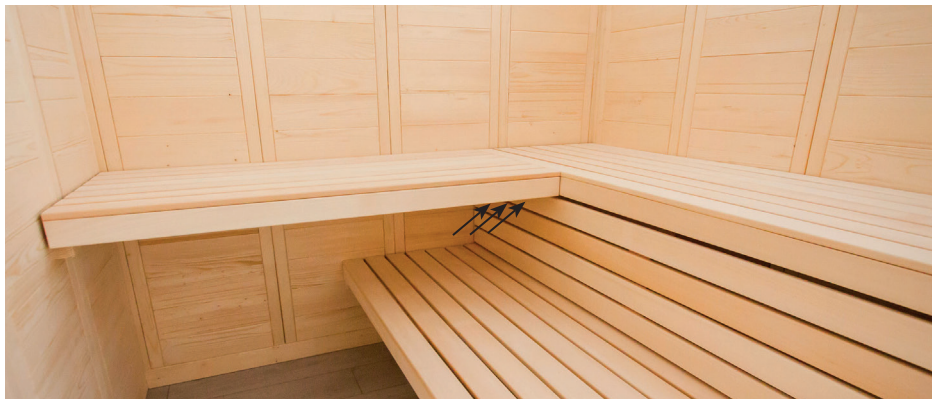

Bohrer 3 mm, 3 Stk. Schrauben 5 x 70 mm



Infrarot-Strahler und Rückenlehnen

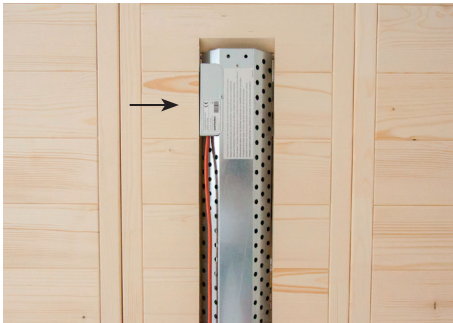

Anschlussbox oben



Beschriftung lesbar



4 Stk. Schrauben 3 x 18 mm



4 Stk. Schrauben 4 x 60 mm

DE



Bohrer 3mm, 8 Stk. Schrauben 3,5 x 40 mm

2.6. Montage Zubehör

Saunaleuchte



Leuchtmittel einsetzen
(nicht im Lieferumfang enthalten)



Bohrer 3mm, 2 Stk. Schrauben

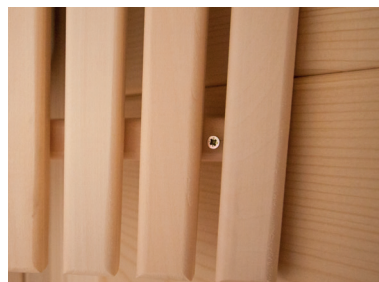

4 Stk. Schrauben 3,5 x 40 mm

Ofenschutzgitter



Bohren Sie vor der Montage des Ofenschutzgitters den Auslass für das Ofenkabel im Elektroelement.



4 Stk. Schrauben 3,5 x 40 mm

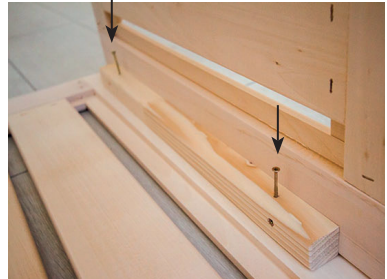

DE



Symbolfoto

4 Stk. Schrauben 3,5 x 40 mm

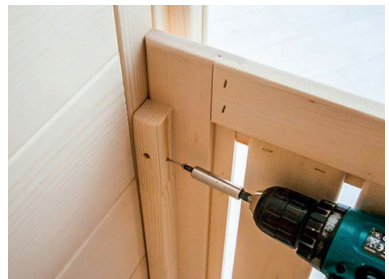

2.7. Montage Glastür

Die Glastür kann links und rechts angeschlagen werden.

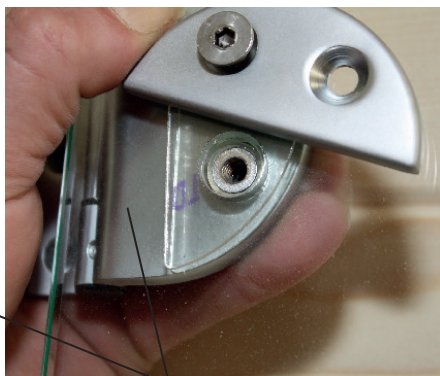
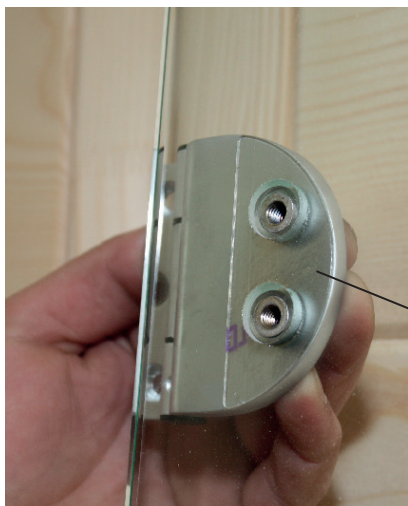

Silikon- oder Papierbeilage für Glas-
türbeschläge auf beiden Seiten der
Glastüre einlegen

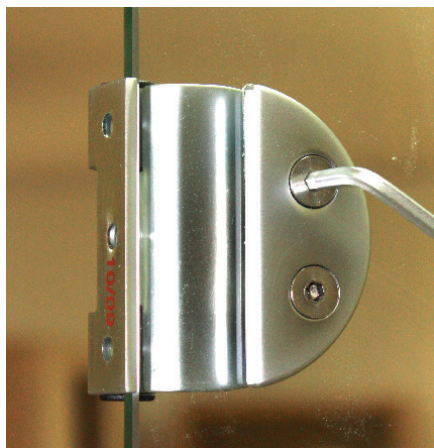

Schrauben 4 x 30 mm

Türgriff und Überschubblech

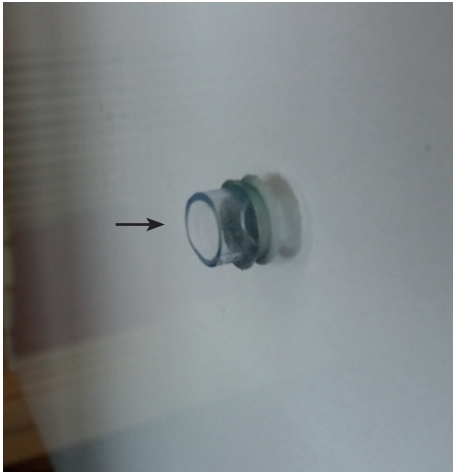

Silikonring in Bohrungen einlegen



Kunststoff Beilagscheibe bei Niro-Griff beilegen



Türmagnet

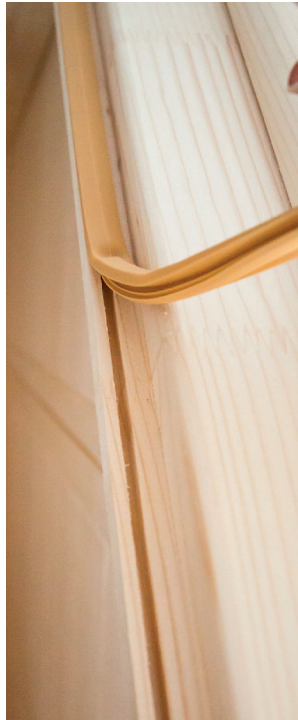

2.8. Montage Dachkranz



Montieren Sie den Dachkranz erst nachdem Sie die Kabel zum Saunaofen und zur Saunasteuerung eingezogen haben. Möglicherweise muss die Leiste beim Elektroelement ausgeschnitten werden.



Bohrer 3 mm, 11 Stk. Schrauben 3,5 x 40 mm

2.9. Montage Dachabdeckleiste



Montieren Sie die Dachabdeckleiste erst nachdem Sie die Kabel zum Saunaofen und zur Saunasteuerung eingezogen haben. Möglicherweise muss die Leiste beim Elektroelement ausgeschnitten werden.



20 Stk. Schrauben 3,5 x 40 mm

3. Grundriss

3.1. Grundriss „links“

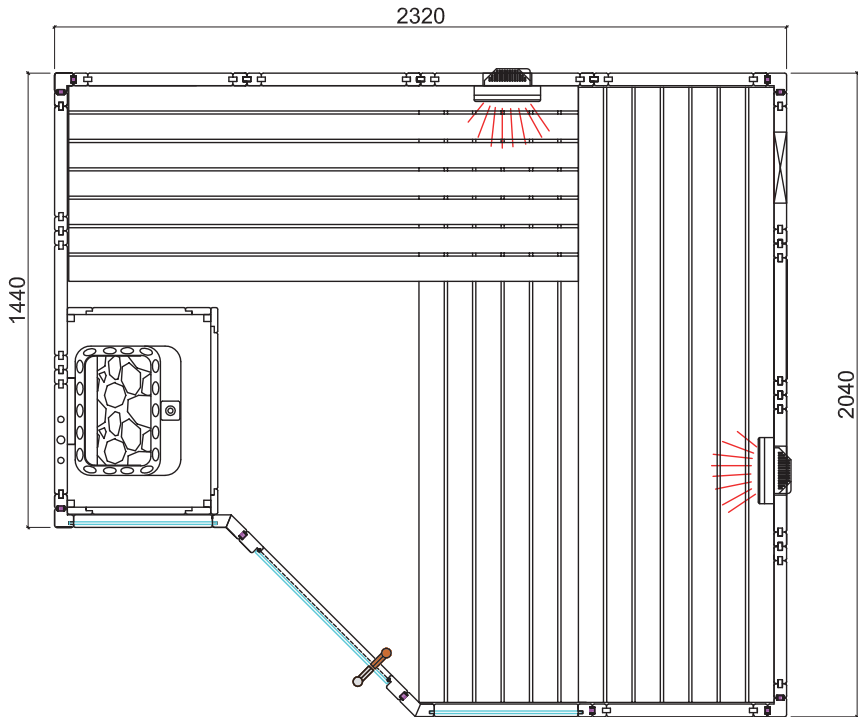

3.2. Grundriss „rechts“

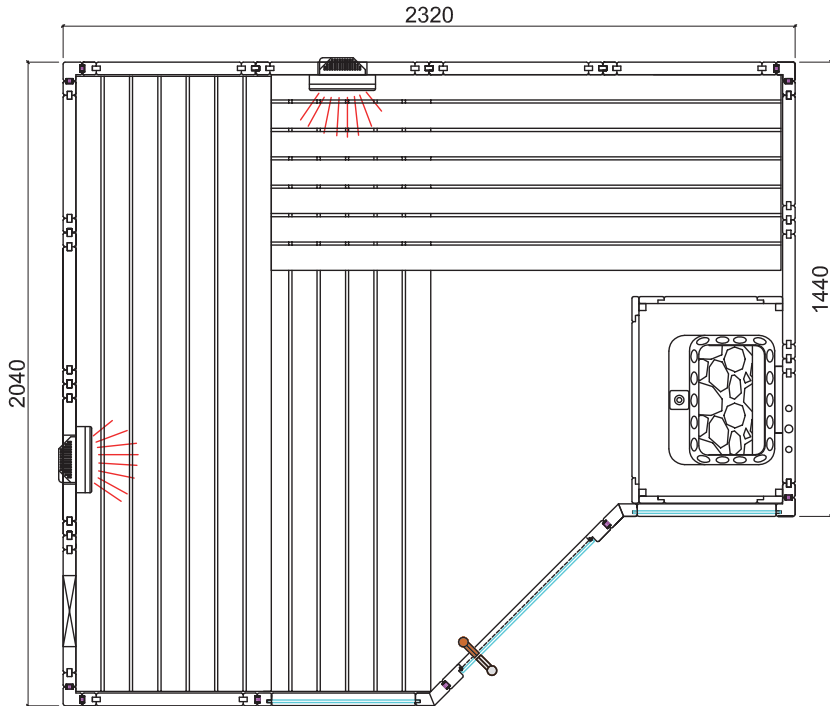

3.3. Änderungen bei Montage Grundriss „rechts“

Für die Montage von Ecksteher und Steher für das Glas (Seite 14)

Entfernen Sie die Multiclips vom Ecksteher und den Stehern für Glas.

Verwenden Sie die beiliegende Schablone für die neue Positionierung der Multiclips.

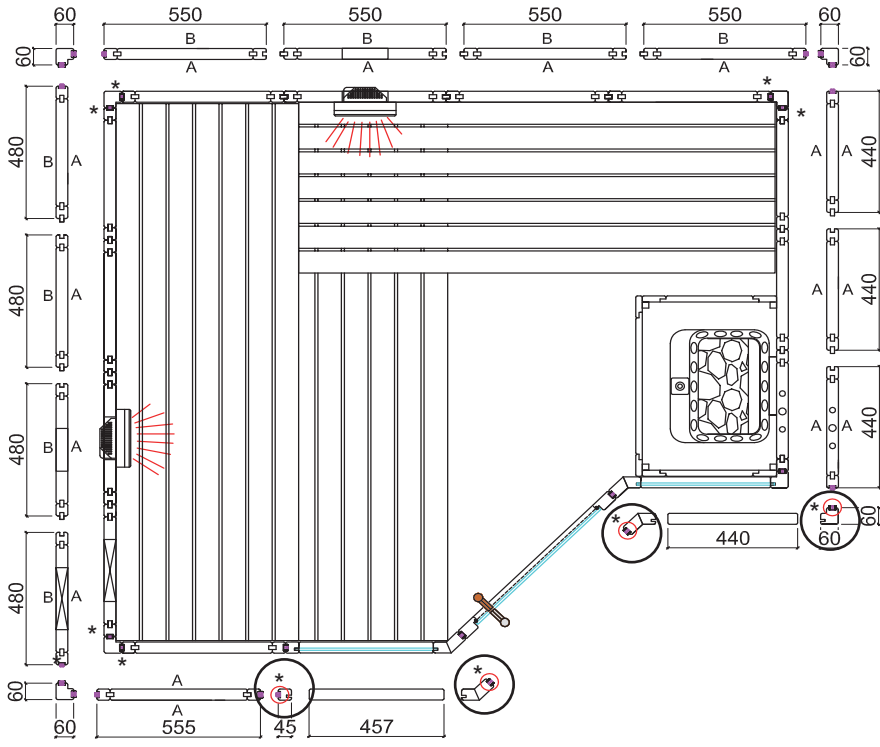

* Multiclips



Sauna en bois massif

ARKTIS

INFRA +

234 x 206 x 204 cm

INSTRUCTIONS DE MONTAGE ET MODE D'EMPLOI
Français

FR



Table des matières

| | |
|---------------------------------------------------------------|-----------|
| 1. Préparation du montage | 3 |
| 1.1. Outils requis | 4 |
| 1.2. Entretien et nettoyage | 5 |
| 1.3. Élimination | 5 |
| 1.4. Nomenclature ARKTIS INFRA+ | 6 |
| 2. Montage de la cabine | 9 |
| 2.1. Montage du cadre de plancher | 9 |
| 2.2. Montage des éléments muraux | 10 |
| 2.3. Montage du toit | 17 |
| 2.4. Montage du registre d'aération | 19 |
| 2.5. Montage de l'équipement intérieur | 19 |
| 2.6. Montage des accessoires | 26 |
| 2.7. Montage de la porte en verre | 28 |
| 2.8. Montage de la couronne | 31 |
| 2.9. Montage de la baguette couvre-joint | 32 |
| 3. Plan | 33 |
| 3.1. Plan « à gauche » | 33 |
| 3.2. Plan « à droite » | 34 |
| 3.3. Modifications lors du montage selon le plan « à droite » | 35 |

1. Préparation du montage

Lisez attentivement les présentes instructions de montage et gardez-les à proximité de l'appareil. Vous avez ainsi accès à tout moment aux informations sur le produit.



Vous trouverez également ces instructions de montage dans la rubrique de téléchargement de notre site Internet www.sentiotec.com/downloads.

Remarques importantes :

- Avant de commencer les travaux, vérifiez au moyen de la nomenclature si toutes les pièces ont bien été livrées. S'il devait s'avérer que des pièces manquent, informez votre revendeur dans les 14 jours suivant la réception de la cabine.
- La pièce dans laquelle la cabine de sauna va être montée doit être sèche et disposer d'une circulation suffisante de l'air.
- Le sol doit être horizontal et lisse, de préférence en pierre ou carrelage.
- Pour les travaux de montage de la cabine, la pièce doit faire au moins 230 cm de haut.
- Une distance d'au moins 5 cm avec le mur doit être respecté.
- Les pièces en bois prévues pour l'intérieur ne doivent pas être traitées avec un agent d'imprégnation.
- Une deuxième personne doit être disponible pour vous aider.
- Malgré un stockage correct, le bois est un produit naturel qui peut gonfler, se contracter ou se déformer. C'est pourquoi il peut arriver que vous ayez à appliquer de la force lors du montage.
- Tous les raccords vissés doivent être préalésés.

Attention !

Seul un électricien spécialisé ou une personne ayant une qualification similaire est habilité à procéder au raccordement électrique.

1.1. Outils requis

- Marteau et cales ou maillet en caoutchouc
- Visseuse électrique avec bits pour vis en croix et Torx
- Ruban de mesure
- Foret de 3 mm de diamètre, 10 mm, 20 - 30 mm (pour câble électrique poêle de sauna)
- Niveau à bulle
- Clé Allen 1,5 mm
- Couteau universel
- Échelle
- Scie fine



Ce symbole désigne les conseils et indications utiles.

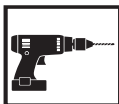

Préalésage



Sciage à la bonne longueur avec une scie fine



Contrôle de l'angle droit :

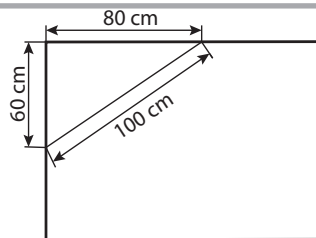

Manipulez le verre avec soin : Faire particulièrement attention avec les bords de la vitre ; en cas de choc, le verre trempé peut se briser en petits morceaux. Placez un rembourrage de protection (par ex., un emballage en carton) sous le bord de la vitre.

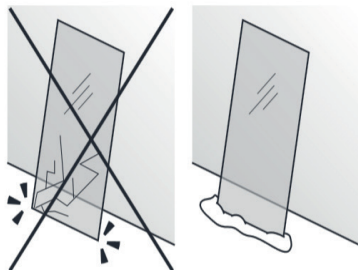

1.2. Entretien et nettoyage

- Le sauna doit être nettoyé au moyen d'un chiffon humide. N'utilisez que de l'eau chaude, pas de détergent.
- Si le sauna n'est pas utilisé pendant une période prolongée, nous recommandons de chauffer la cabine une fois par mois.



Les poches de résine ne constituent pas un motif de réclamation. en raison de leur présence régulière dans le bois d'épicéa et de l'impossibilité de déterminer leur profondeur lors de la sélection du bois.

Si elles se trouvent juste sous la surface, elles éclatent et s'écoulent quand elle sont exposées à la chaleur.

Retirez la résine écoulee à l'aide "un chiffon imbibé d'acétone. Si vous constatez uniquement des gouttes de résine, attendez qu'elles aient durci, puis grattez-les avec précaution à l'aide d'un couteau.

1.3. Élimination



- Éliminez les matériaux d'emballage conformément aux directives en vigueur relatives à l'élimination.
- Les appareils usagés contiennent des matériaux recyclables, mais aussi des substances toxiques. Par conséquent, ne jetez en aucun cas votre appareil usagé avec les déchets ménagers. Éliminez-le conformément aux directives locales en vigueur.

1.4. Nomenclature ARKTIS INFRA+

| Az | Désignation | Dimensions |
|--------------------------|----------------------------------------------------------|-------------------|
| Cadre de plancher | | |
| 2 | Cadre de plancher | 204 x 9 x 4 cm |
| 1 | Cadre de plancher | 138 x 9 x 4 cm |
| 1 | Cadre de plancher | 61,5 x 9 x 4 cm |
| 1 | Cadre de plancher | 32 x 9 x 4 cm |
| Éléments muraux | | |
| 1 | Éléments muraux A/B avec découpe de radiateur | 193 x 48 x 4 cm |
| 1 | Éléments muraux A/B | 193 x 48 x 4 cm |
| 1 | Éléments muraux A/B avec multclip | 193 x 48 x 4 cm |
| 1 | Élément de ventilation A/B avec multclip | 193 x 48 x 4 cm |
| 1 | Élément mural A/A avec multclip | 193 x 44 x 4 cm |
| 1 | Éléments électriques A/A avec multclip | 193 x 44 x 4 cm |
| 1 | Élément mural A/A | 193 x 44 x 4 cm |
| 1 | Élément mural A/A avec multclip | 193 x 55,5 x 4 cm |
| 2 | Élément mural A/B avec multclip | 193 x 55 x 4 cm |
| 1 | Élément mural A/B avec découpe de radiateur | 193 x 55 x 4 cm |
| 1 | Élément mural A/B | 193 x 55 x 4 cm |
| 1 | Élément au-dessus du verre | 45,5 x 8,6 x 4 cm |
| 1 | Élément au-dessus du verre | 44 x 8,6 x 4 cm |
| Éléments du toit | | |
| 1 | Éléments de toit A/B | 194 x 55 x 4 cm |
| 1 | Élément de toit A/B | 194 x 56 x 4 cm |
| 1 | Élément de toit A/A | 138,6 x 56 x 4 cm |
| 1 | Élément de toit A/A incliné | 194 x 55 x 4 cm |
| Montant d'angle | | |
| 3 | Montant d'angle 90° avec multclip | 193 x 6 x 6 cm |
| 2 | Montant d'angle 45° à côté de porte avec multclip | 202 x 7,8 x 4 cm |
| 1 | Montant d'angle 90° avec rainure et multclip | 202 x 7,8 x 4 cm |
| 1 | Montant pour élément en verre rainure 8 mm avec multclip | 202 x 4,5 x 4 cm |

| Az | Désignation | Dimensions |
|-----------------------------|----------------------------------------------------------------------------------|--------------------|
| Baguettes d'appui | | |
| 2 | Baguette d'appui de toiture | 115 x 4 x 4 cm |
| 1 | Baguette d'appui de toiture | 196 x 4 x 4 cm |
| 1 | Baguette d'appui de toiture | 136 x 4 x 4 cm |
| 1 | Baguette d'appui de toiture 1 x 22,5 ° | 54 x 4 x 4 cm |
| 1 | Baguettes d'appui de toiture 1 x 22,5° | 112 x 4 x 4 cm |
| 1 | Baguette d'appui de toiture 2 x 22,5° | 86,5 x 4 x 4 cm |
| 2 | Baguette couvre-joint de toiture | 114 x 1,2 x 4 cm |
| 1 | Baguette couvre-joint de toiture | 200 x 1,2 x 4 cm |
| 1 | Baguette couvre-joint de toiture | 140 x 1,2 x 4 cm |
| 1 | Baguette d'appui de toiture 1 x 22,5° | 54,8 x 1,2 x 4 cm |
| 1 | Baguettes d'appui de toiture 1 x 22,5° | 114,8 x 1,2 x 4 cm |
| 1 | Baguette d'appui de toiture 2 x 22,5° | 86,5 x 1,2 x 4 cm |
| 1 | Baguette d'appui de banc 1 x 45° | 116 x 4 x 4 cm |
| 1 | Baguette d'appui de banc | 110 x 4 x 4 cm |
| 3 | Baguettes d'appui de banc | 58 x 4 x 4 cm |
| 2 | Baguettes de montage pour écran de banc | 26 x 4 x 4 cm |
| Équipement intérieur | | |
| 2 | Bancs | 195 x 62 x 9 cm |
| 1 | Banc | 161,5 x 62 x 9 cm |
| 1 | Baguette couvre-joint de banc | 45,7 x 14 x 2 cm |
| 1 | Dossier | 122 x 26 x 5 cm |
| 1 | Dossier | 105 x 26 x 5 cm |
| 1 | Dossier | 67 x 26 x 5 cm |
| 1 | Dossier | 56 x 26 x 5 cm |
| 1 | Écran de banc | 195 x 35 x 5 cm |
| 1 | Grille de protection de poêle en 3 parties 1 x 65,5 x 75 cm, 2 x 45,5 x 55 cm | 65,5 x 475 x 75 cm |
| 1 | Grille de plancher | 70 x 53 x 4 cm |
| 2 | Appuie-tête | 43 x 25 x 7 cm |
| 1 | Grille de protection de lampe | 38 x 32 x 4 cm |
| 1 | Registres d'aération | 52 x 14 x 1,5 cm |

| Az | Désignation | Dimensions |
|---------------------------------|-----------------------------------------------------------|-----------------------|
| Éléments en verre | | |
| 1 | Porte en verre | 191,5 x 68 x 0,8 cm |
| 1 | Élément en verre | 194,5 x 48,1 x 0,8 cm |
| 1 | Élément en verre | 194,5 x 46,4 x 0,8 cm |
| Baguettes de la couronne | | |
| 1 | Baguettes de la couronne 1 x 45° | 151 x 6 x 4 cm |
| 1 | Baguette de la couronne 1 x 22,5° et 1 x 45° | 56,3 x 6 x 4 cm |
| 1 | Baguette de la couronne 1 x 22,5° | 123,5 x 6 x 4 cm |
| 1 | Baguette de la couronne 2 x 22,5° | 84,9 x 6 x 4 cm |
| Accessoires | | |
| 1 | Profilé en U alu | 45,7 x 1,2 x 1,5 cm |
| 1 | Profilé en U alu | 44 x 1,2 x 1,5 cm |
| 1 | Kit poignée bois/inox | |
| 1 | 2 charnières 3308 | |
| 1 | Aimant de porte, tôle extérieure | |
| 1 | Éclairage de sauna | |
| 2 | Émetteurs infrarouges ECO-350-R | 1-027-785 |
| 2 | Panneaux de recouvrement de radiateur Prestige | 71 x 21 x 5 cm |
| 1 | Infrabox basic set | 1-035-705- |
| 1 | Câble WC4-GST-C05 1-028 | 1-028-862 |
| 1 | Distributeur IR-1P2 | 1-028-731 |
| 1 | Gabarit pour montage Multiclip | |
| 1 | 3 mètres linéaires Câble silicone 5 x 2,5 mm ² | |
| 1 | 3 mètres linéaires Câble silicone 3 x 1,5 mm ² | |
| 1 | Kit de matériel de montage | |
| 1 | Instructions de montage | |

2. Montage de la cabine

La cabine peut être montée « à gauche » ou « à droite ». Référez-vous aux plans Page 33 et Page 34.

2.1. Montage du cadre de plancher

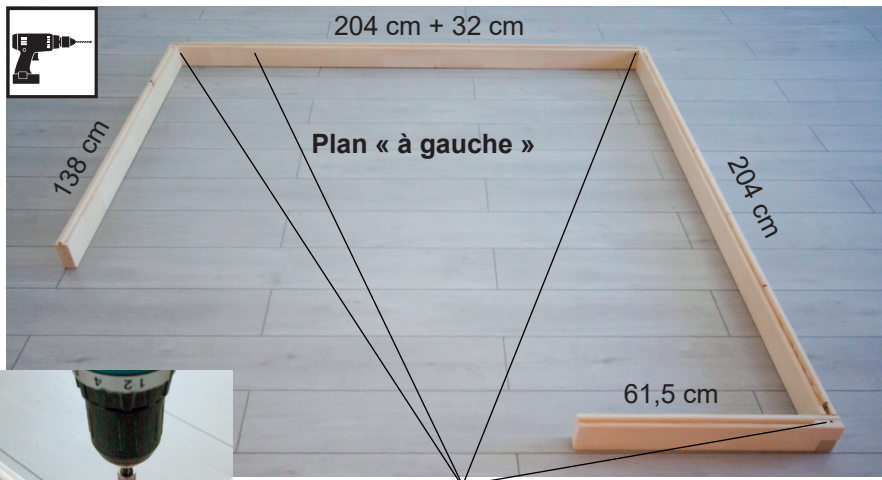

Plan « à gauche »

Foret de 3 mm, 4 vis 4 x 70 mm

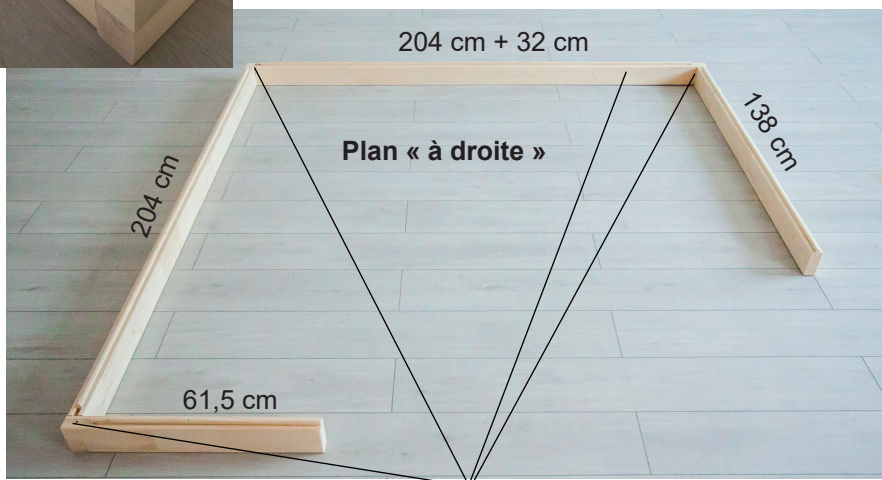

Plan « à droite »

Foret de 3 mm, 4 vis 4 x 70 mm

2.2. Montage des éléments muraux

Fixez les montants d'angle aux éléments muraux au moyen des « multiclips ». Les autres éléments muraux sont reliés par des rainures et des languettes, et sont vissés les uns aux autres.



A désigne toujours le côté apparent qui est indiqué sur la face supérieure des éléments muraux.

Attention !

Ci-après, le montage du plan « à gauche » est décrit. Pour toutes modifications relatives au montage selon le plan « à droite », voir Page 34.

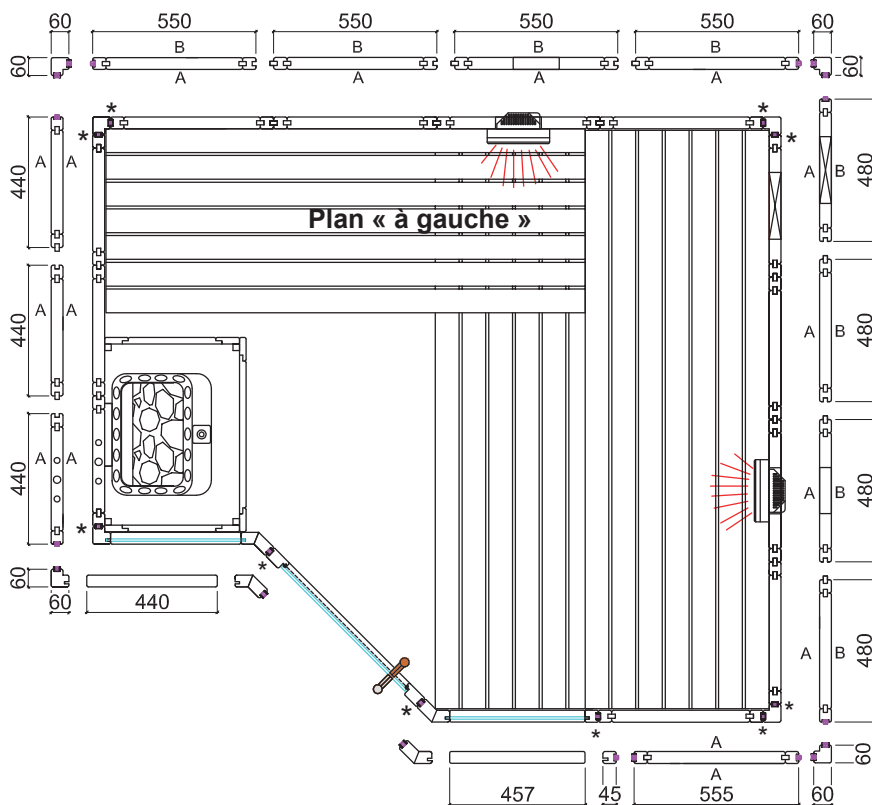

* Multiclips

Montage des montants d'angle sur les éléments muraux



Prémontez les éléments muraux et les montants d'angle au sol, puis placez ces angles sur le cadre de plancher.

Placez le montant d'angle du haut vers le bas sur les éléments muraux. Assurez-vous que l'orientation des « multiclips » est correcte (voir ci-dessous). Le montant d'angle doit être à fleur avec les éléments muraux.

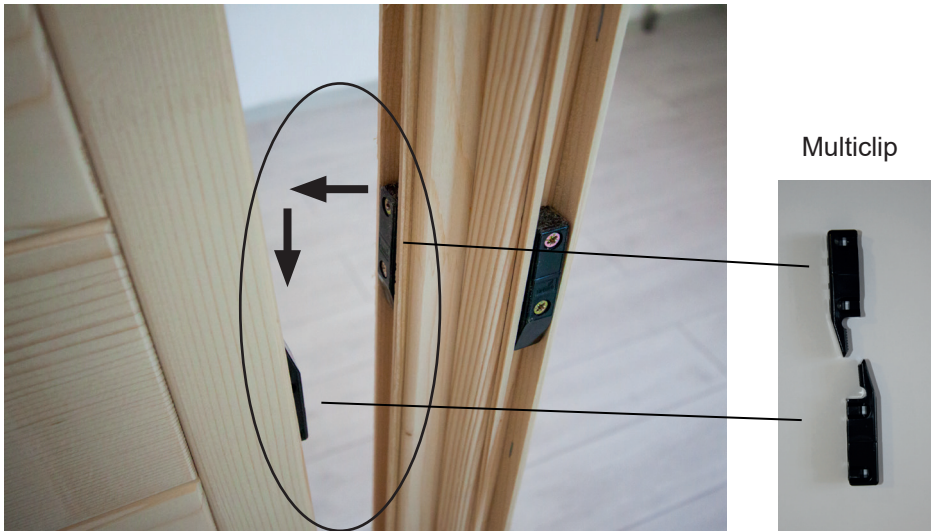

FR



Montage des éléments muraux



Des trous sont prévus sur l'élément électrique afin de poser le câble.
Pour la position, consultez Page 33 et Page 34.

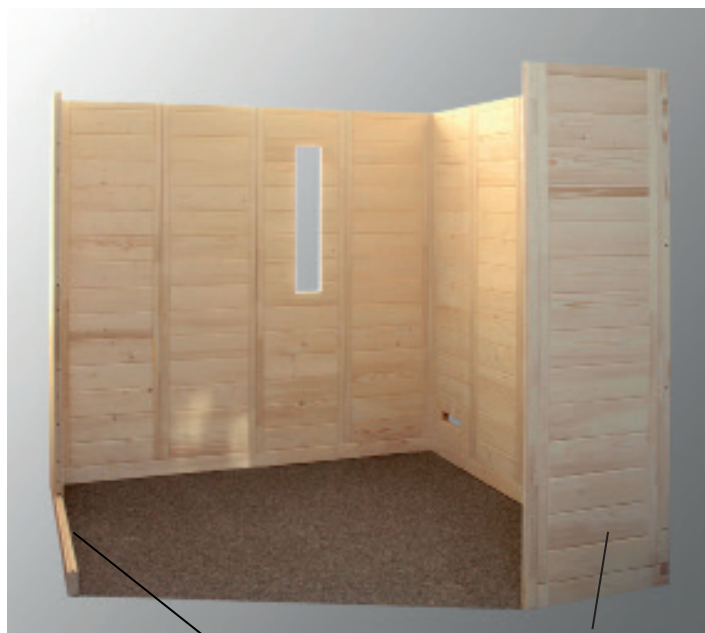
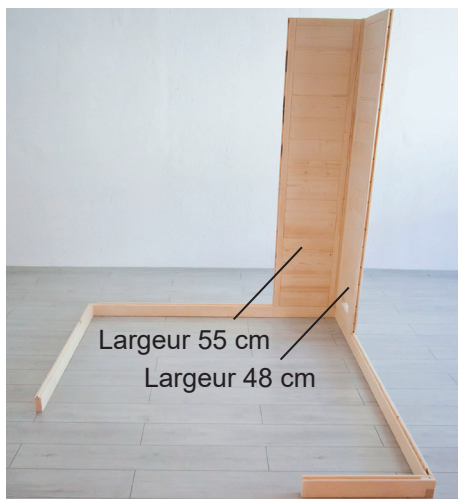

Vissage des éléments muraux



Contrôlez les angles droits avant de visser les éléments muraux.
Consultez le conseil page 4.



Foret de 3 mm, 8 vis 4 x 70 mm

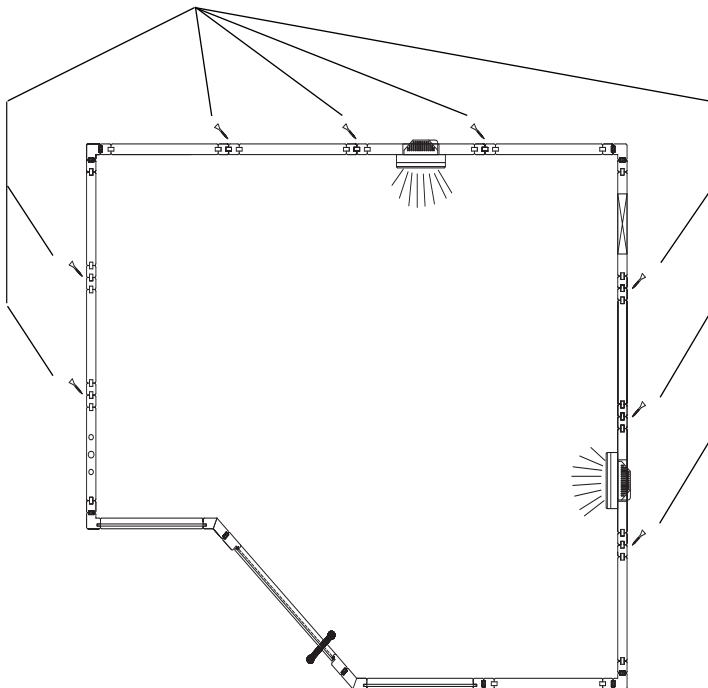

Montant d'angle et montant pour verre



Éléments en verre

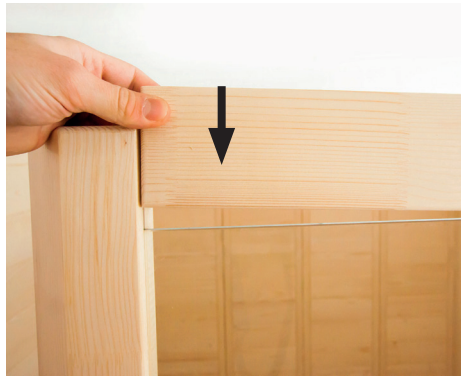

FR



Foret de 3 mm,
1 vis 4 x 70 mm



Foret de 3 mm,
1 vis 4 x 70 mm

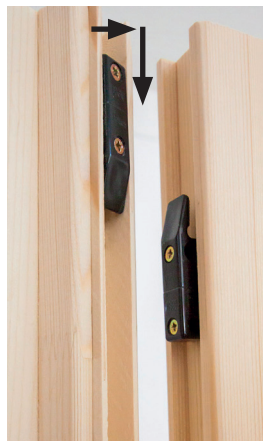

Türstock einsetzen



Retirer la barre de transport du cadre de porte



Insérer le cadre de porte

2.3. Montage du toit Baguettes d'appui de toit

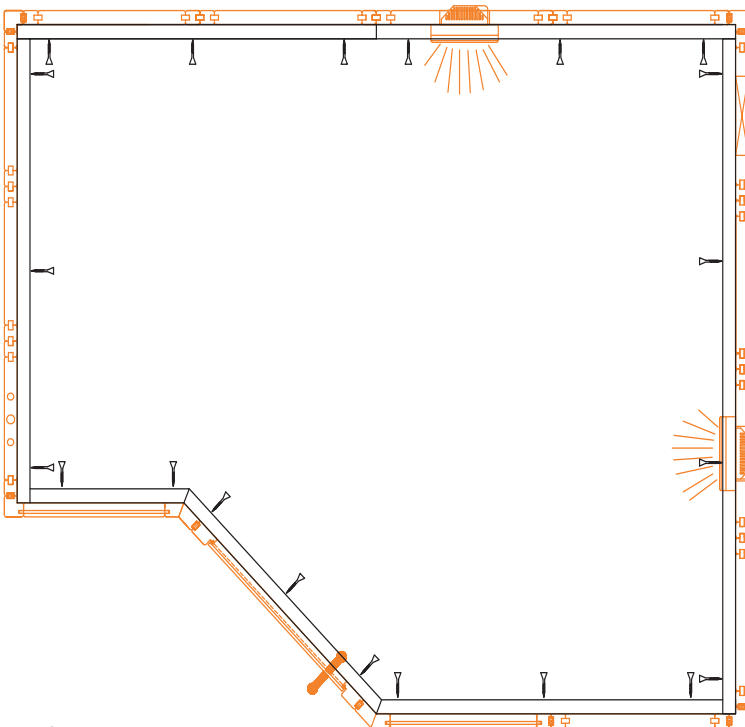

21 vis 4 x 70 mm

Éléments du toit

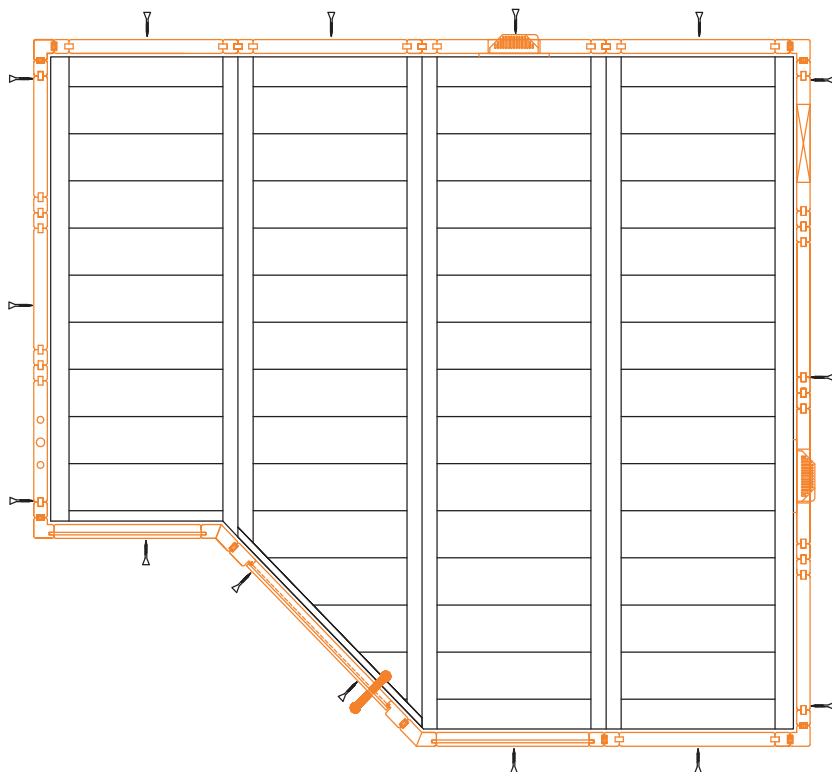

Foret de 3 mm, 15 vis 4 x 70 mm

2.4. Montage du registre d'aération



Foret de 3 mm, 4 vis 3,5 x 40 mm

2.5. Montage de l'équipement intérieur

Baguettes d'appui de banc

Foret de 3 mm, 3 vis 5 x 70 mm



2 vis 4 x 60 mm

Foret de 3 mm, 3 vis 5 x 70 mm

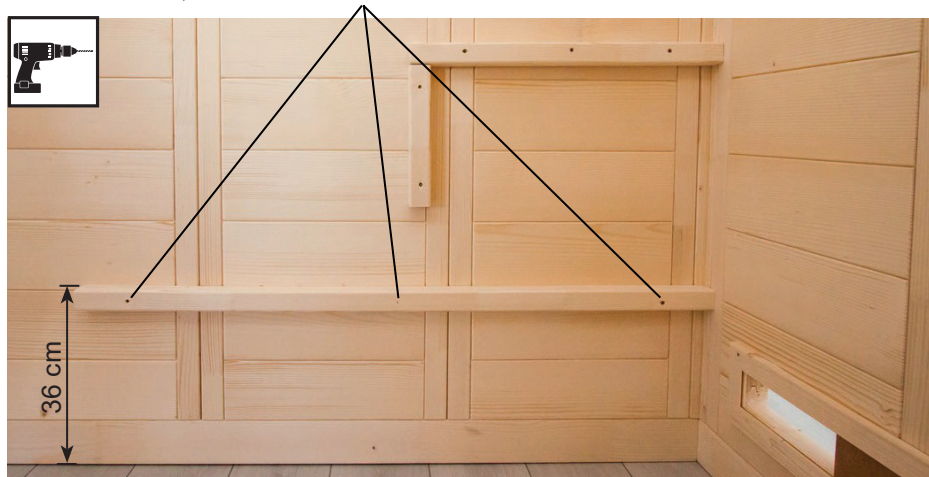

Foret de 3 mm, 3 vis 5 x 70 mm

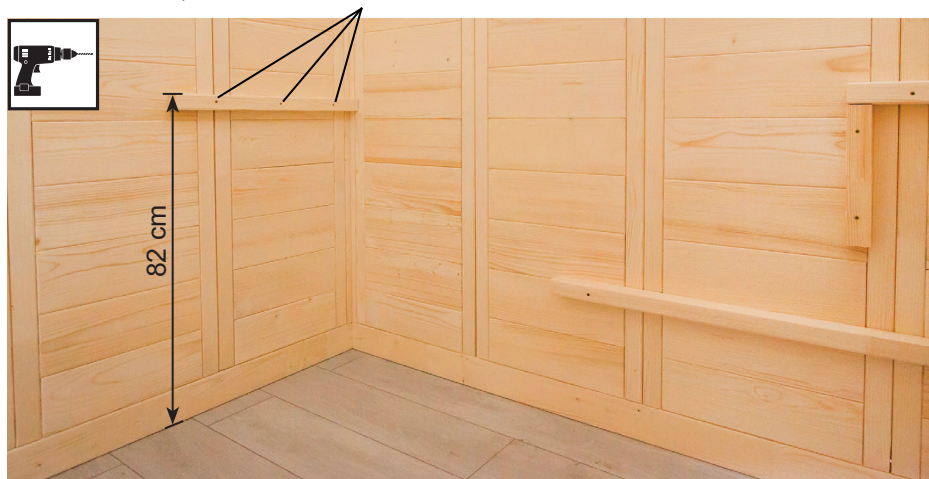

Baguette d'appui de banc avec cache devant la pièce en verre

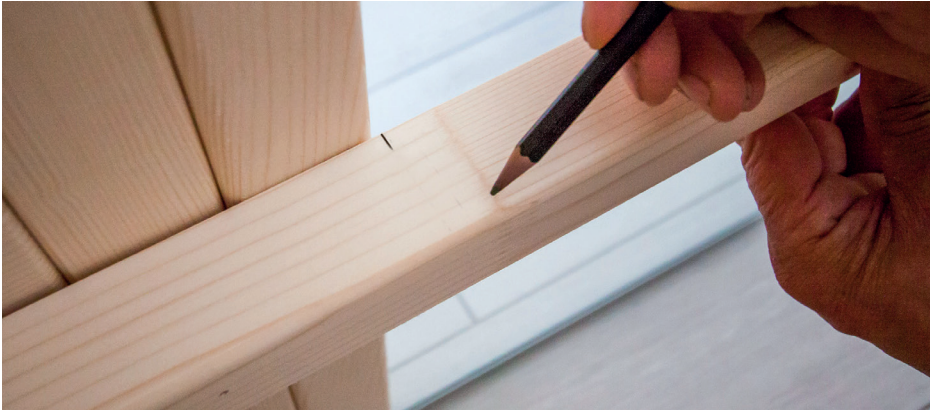

FR



2 vis 4 x 60 mm



3 Vis 5 x 70 mm



2 vis 4 x 60 mm



Écran de banc



FR

4 vis 4 x 60 mm

Banc

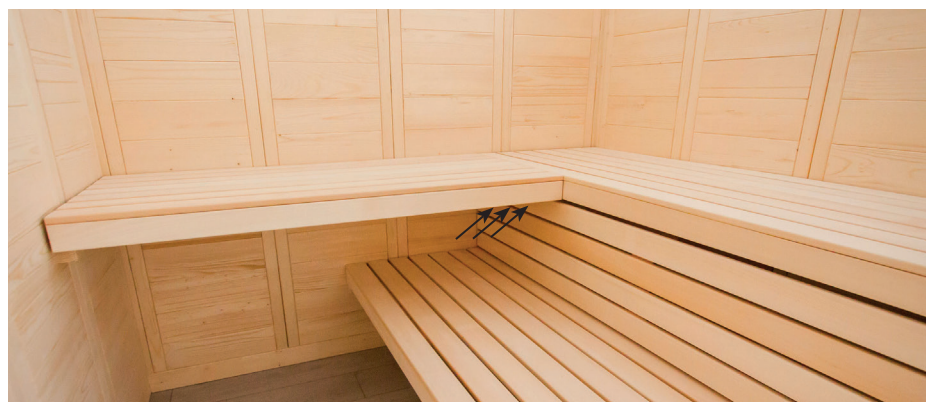

Foret de 3 mm, 3 vis 5 x 70 mm



Radiateur infrarouge et dossiers

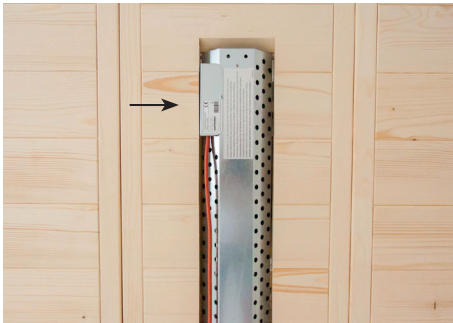

Boîtier de raccordement en haut



Inscription lisible



4 vis 3 x 18 mm



4 vis 4 x 60 mm

FR



Foret de 3 mm, 8 vis 3,5 x 40 mm

2.6. Montage des accessoires

Éclairage de sauna



Mise en place des ampoules
(non compris dans la livraison)



Foret de 3 mm, 2 vis

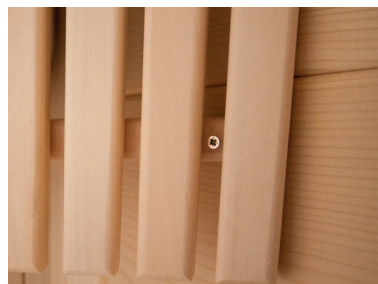

4 vis 3,5 x 40 mm

Grilles de protection de poêle

 Avant le montage de la grille de protection du poêle, percez la sortie pour le câble du poêle dans l'élément électrique.



4 vis 3,5 x 40 mm

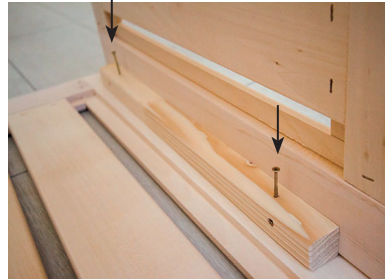

Photo symbolique

4 vis 3,5 x 40 mm



2.7. Montage de la porte en verre

La porte en verre peut être ouverte à gauche ou à droite.

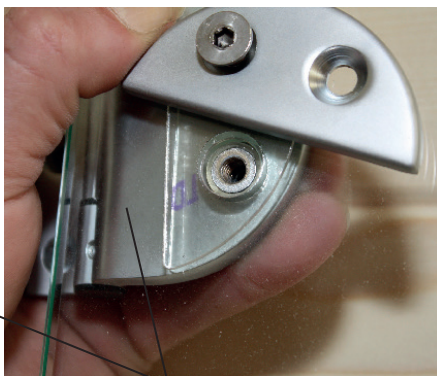
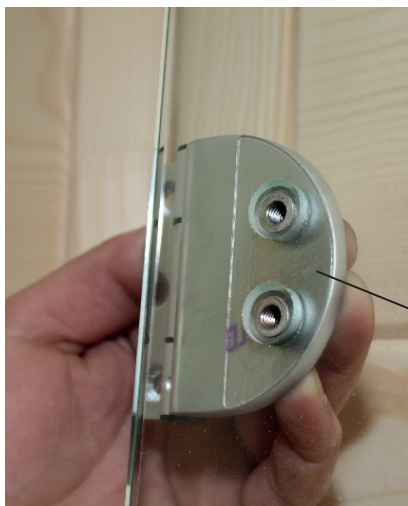

Insérer l'insert en silicone ou en papier pour ferrures de porte en verre des deux côtés de la porte en verre

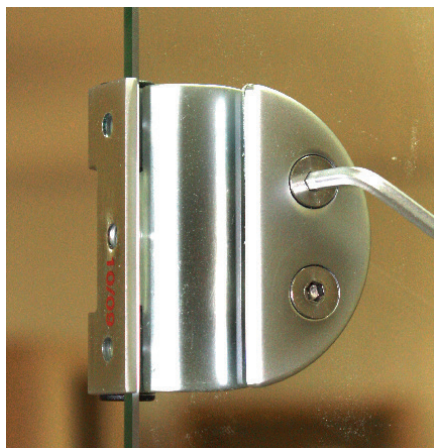

Vis 4 x 30 mm

Poignée de porte et tôle extérieure

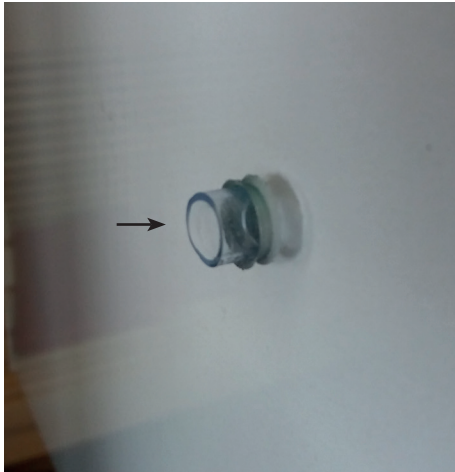

Introduction de la bague en silicone dans les alésages



Pose des rondelles de calage en plastique pour poignée inox



Aimant de porte

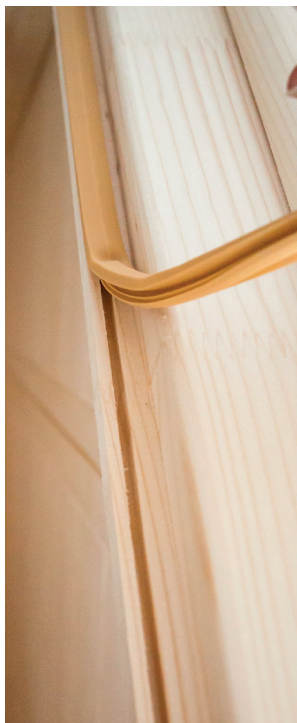

2.8. Montage de la couronne



Ne montez la couronne qu'après avoir inséré les câbles vers le poêle de sauna et la commande de sauna. La baguette au niveau de l'élément électrique doit éventuellement être coupée.



Foret de 3 mm, 11 vis 3,5 x 40 mm

2.9. Montage de la baguette couvre-joint



Ne montez la baguette couvre-joint qu'après avoir inséré les câbles menant au poêle de sauna et à la commande de sauna. La baguette au niveau de l'élément électrique doit éventuellement être coupée.



20 vis 3,5 x 40 mm

3. Plan

3.1. Plan « à gauche »

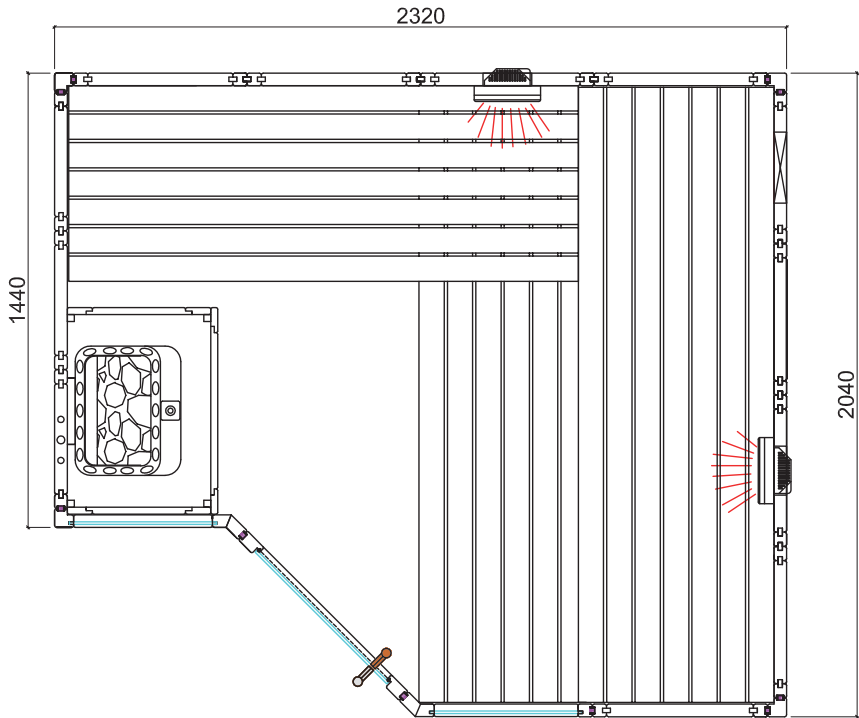

3.2. Plan « à droite »

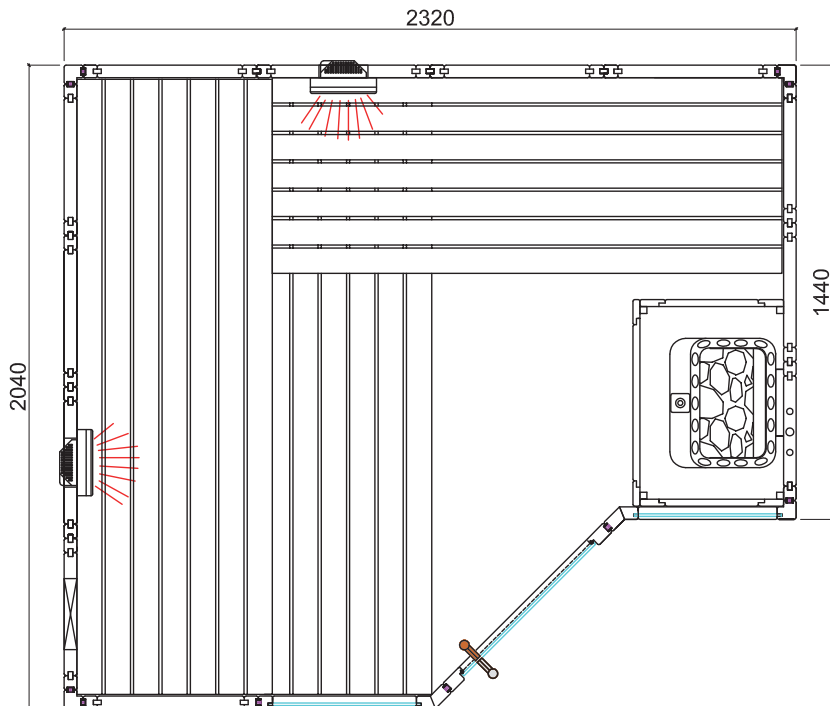

3.3. Modifications lors du montage selon le plan « à droite » Pour le montage de montants d'angle et de montants pour le verre (page 14)

Retirez les multiclips pour montant d'angle et montants pour le verre.

Utilisez les gabarits fournis pour le nouveau positionnement des multiclips.

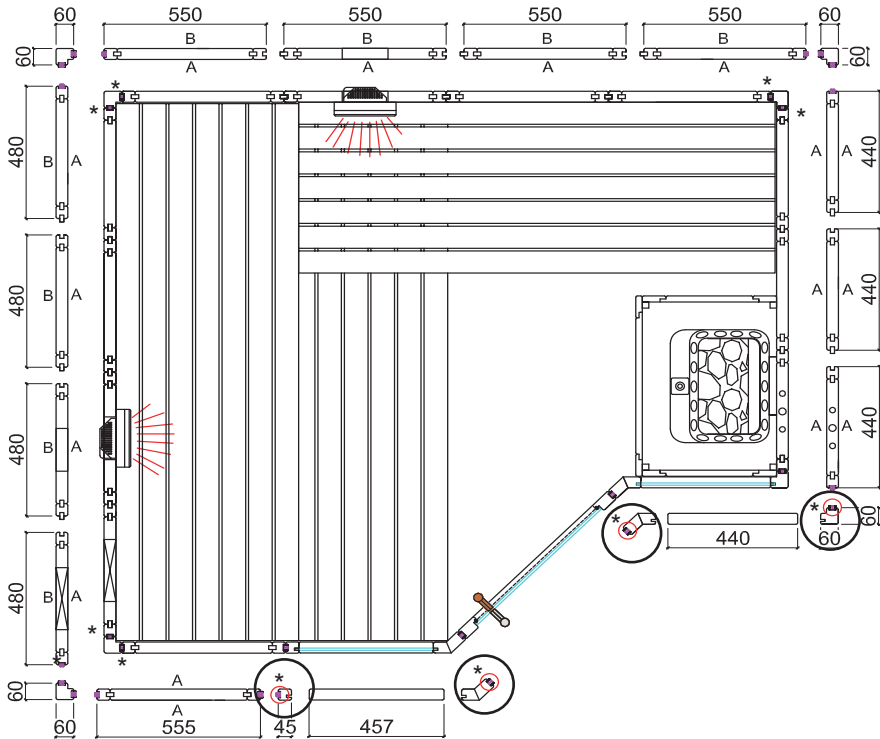

* Multiclips





sentiotec GmbH | Division of Harvia Group | Wartenburger Straße 31, A-4840 Vöcklabruck
T +43 (0) 7672/22 900-50 | F -80 | info@sentiotec.com | www.sentiotec.com